

OWNER'S MANUAL

TRACKER



OFF ROADTM

TRACKER EV iS
72V Electric

10015514-A

The following information is needed when contacting us concerning service or parts for your vehicle:

Vehicle Model: _____

PIN or Serial Number: _____

Manufacture Date Code: _____

California Proposition 65



WARNING

Operating, servicing and maintaining a passenger vehicle or off-road vehicle can expose you to chemicals including phthalates and lead, which are known to the State of California to cause cancer and birth defects or other reproductive harm. To minimize exposure, wear gloves and wash your hands frequently when servicing your vehicle.

For more information go to www.P65Warnings.ca.gov/passenger-vehicle.

OWNER'S MANUAL

72V Electric TRACKER EV iS

Starting MODEL YEAR 2021

MANUFACTURER INFORMATION

Textron Specialized Vehicles Inc.
1451 Marvin Griffin Road
Augusta, Georgia, USA 30906-3852

Dealer: 800-296-4804
Consumer: 877-394-6727

www.trackeroffroad.com

WELCOME

Thank you for purchasing this vehicle. Before driving your new vehicle, read this owner's manual to familiarize yourself with safe driving practices, operation, features and controls.

This manual contains instructions for minor maintenance only. Information about major repairs can be found in the repair manual. Your dealer has thorough knowledge of your vehicle and wants your total satisfaction with your purchase. We recommend you return to your dealership for all of your service needs during, and after the warranty period.

Repair or replacement parts can be purchased from your dealer or through the manufacturer's parts and accessories department.

These are original instructions as defined by 2006/42/EC.

The manufacturer maintains the right to change the design of the vehicle without responsibility to make the changes on units purchased before changes were made. The information in this manual can change without notice.

All information in this owner's manual is based on the latest product information at the time of publication. Due to constant improvements in the design and quality of production components, some discrepancies may be found between your vehicle and the information presented in this publication. The content in this publication is intended for reference use only. The manufacturer is not liable for omissions or inaccuracies. Any reprinting or reuse of the content in this publication, whether whole or in part, is expressly prohibited.

Issued Date: July 2020

Revised Date:

10015514-A

Printed in USA

INTRODUCTION

MANUFACTURER'S INTENDED USE 4
 WARRANTY AND REGISTRATION 4
 VEHICLE IDENTIFICATION NUMBERS 5
 REPAIR AND PARTS MANUALS 5

SAFETY

SAFETY LABELS 7
 OPERATOR WARNING (P/N 695306) 7
 BATTERY WARNING (P/N 640561) 7
 REAR PASSENGER SAFETY WARNING (P/N 628943) 7
 LOAD DECK WARNING (P/N 630398) 8
 SEAT BELTS 8
 MAXIMUM CARGO LOAD / MAXIMUM WEIGHT CAPACITY 8
 TIRE PRESSURE 8
 OPERATOR SAFETY 8
 Unauthorized Use 9
 Operating without Instruction 9
 Alcohol or Drugs 9
 Seat Belts 9
 Passenger 9
 BEFORE OPERATING 9
 Load Operation 9
 Driving in Reverse 9
 Driving a Damaged Vehicle 10
 Driving at High Speeds 10
 Driving on Pavement 10
 Driving on Public Roads 10
 Turning 10
 Jumps and Stunts 10
 Unfamiliar Terrain 10
 Obstacles 10
 Climbing Hills 10
 Driving Downhill 10
 Stalling on a Hill 10
 Parking on a Hill 10
 Tires 10
 Slippery Terrain 10
 Driving on Ice 10
 Vehicle Lifting 10
 Vehicle Modification 10

FEATURES AND CONTROLS

GENERAL INFORMATION 13
 Key Switch / Direction Selector 13
 State of Charge Meter 13
 Light Switch 13
 Max Speed / Range Switch 13
 Auxiliary Switch Positions 13
 12 Volt Power Outlet 13
 Cup Holder 13
 Accelerator Pedal 13
 Brake Pedal 14

TABLE OF CONTENTS

Park Brake	14
Charger Receptacle	14
Taillights	14
Side Nets	14
Seat Belts	14
Rear Seat / Load Deck	15
OPS / Top / Windshield	15
OPERATION	
SAFETY	17
BEFORE INITIAL USE	17
Initial Service Chart	18
Pre - Ride Inspection	18
PORTABLE CHARGER	18
Using the Charger	19
OPERATING THE VEHICLE	20
Key Switch Operation	20
Parking the Vehicle	20
Park Brake Release Switch	21
Emergency Park Brake Release	21
Max Speed / Range Switch	21
Light Switch Operation	21
Brake Operation	21
Accelerator Operation	21
Seat Belt Operation	22
Common Sense Operation	22
Environmental Concerns	22
Starting and Driving	22
Starting the Vehicle on a Hill	23
Coasting	23
Towing a Trailer	23
Terrain	23
Rear Facing Seat/Load Deck	23
WINCH OPERATION	23
MAINTENANCE	
VEHICLE CLEANING AND CARE	27
ROUTINE MAINTENANCE	27
LIFTING THE VEHICLE	27
Lift Entire Vehicle	28
Lift Front of Vehicle	28
Lift Rear of Vehicle	28
Lower Vehicle	28
LIGHT BULB REPLACEMENT	29
Headlight Bulb	29
Taillight Bulb	29
WHEELS AND TIRES	29
Tire Repair	29
Wheel Installation	29
WHEEL ALIGNMENT	30
Front	30
Rear	30
BRAKES	31
Master Cylinder	31
Bleeding Brakes	31
POWERTRAIN	32
AXLES	32
Front and Rear Axles	32

BATTERY CHARGING AND MAINTENANCE 33

- Battery Safety 33
- Battery Disposal 33
- Battery 33
- Battery Maintenance 33
- At Each Charging Cycle 33
- Monthly 33
- Temperature Affects Battery Capacity 34
- Electrolyte Level and Water 34
- Cleaning Batteries 35
- Battery Removal and Installation 36
- Prolonged Storage 37
- Battery Charging 37
- Battery Troubleshooting 37
- Hydrometer 38
- Always wear a safety shield or approved safety goggles when adding water or charging batteries. 39

HARDWARE 40

CAPACITIES AND REPLACEMENT PARTS 40

PERIODIC SERVICE SCHEDULE 41

SPECIFICATIONS

SPECIFICATIONS CHART 43

MAINTENANCE LOG

MAINTENANCE LOG 45

INTRODUCTION

The TRACKER EV/S is an off road vehicle. Familiarize yourself with all laws and regulations concerning the operation of this vehicle in your area. The following symbols appear throughout this manual and on your vehicle. Your safety is involved when these symbols are used. Become familiar with their meanings before reading the manual.



DANGER indicates a hazardous situation that, if not avoided, will result in death or serious injury.



WARNING indicates a hazardous situation, if not avoided, could result in death or serious injury.



CAUTION indicates a hazardous situation that, if not avoided, could result in minor or moderate injury.



The PROHIBITION SAFETY SIGN indicates an action NOT to take in order to avoid hazard.



The MANDATORY ACTION SIGN indicates an action that NEEDS to be taken to avoid a hazard.



Failure to comply with the warnings in this manual can result in severe injury or death.



Read this entire manual carefully before operating this vehicle. Do not attempt to operate this vehicle until you have a thorough knowledge of the controls and features.



Regular inspections and maintenance, along with good operating techniques, will help ensure your safe enjoyment of the capabilities and reliability of this vehicle.

MANUFACTURER'S INTENDED USE

- This vehicle is designed and manufactured for off road use only. Use on public streets, roads, or highways is illegal in most areas and increases the risk of an accident involving other vehicles and people. This vehicle does not meet FMVSS (Federal Motor Vehicle Safety Standards) for public street, road or highway use.
- Check all laws and regulations before choosing an area to operate the *vehicle*.

WARRANTY AND REGISTRATION

All information, including coverage, limitations, exclusions, and how to obtain warranty service is included in the literature package with the purchase of the vehicle.

Registration of the vehicle will be done by the dealer at the time of purchase.

VEHICLE IDENTIFICATION NUMBERS

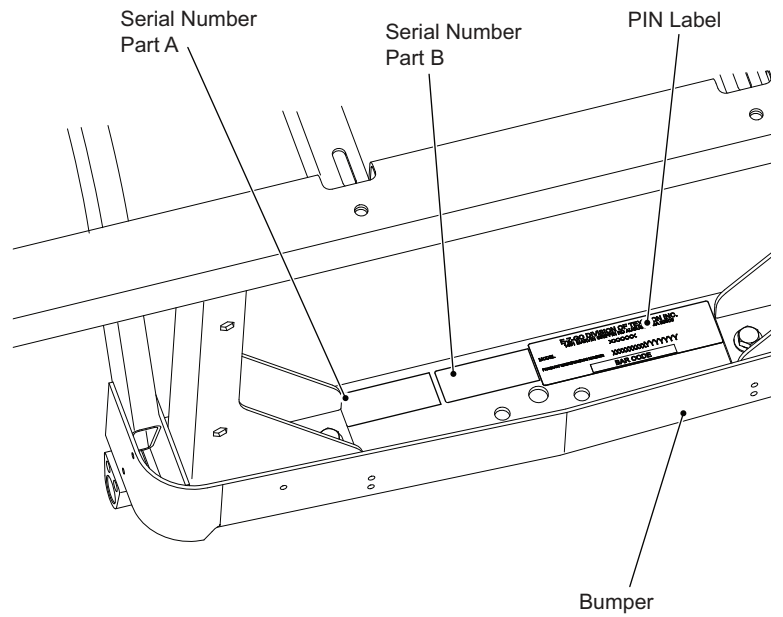
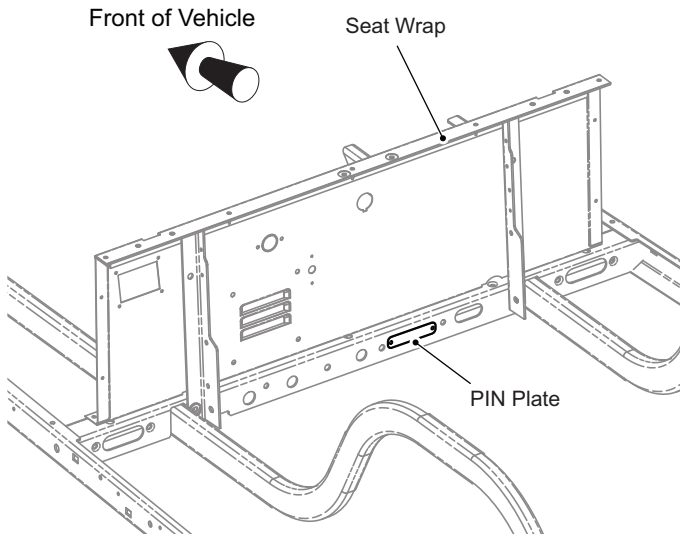

Key Number

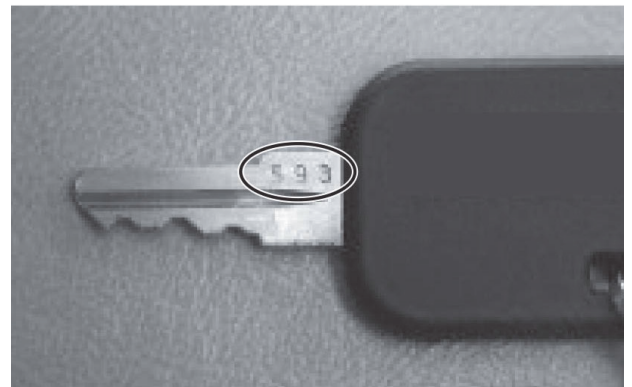

Record the vehicle identification numbers and key number (on the key) in the spaces provided below.

Remove the spare key and store it in a safe place. An ignition key can be duplicated only if the key number is provided. If all keys are lost and the key number is unknown, the ignition switch must be replaced.

The information below is required when ordering parts from the manufacturer.

Vehicle Model Number: _____

Frame PIN: _____

Key Number: _____

REPAIR AND PARTS MANUALS

The following manuals can be purchased through your dealer:

- repair manual
- parts manual

SAFETY

SAFETY LABELS

Safety and warning labels are on the vehicle for your protection. Read and comply with the instructions on the labels. If any label shown in this manual is different from the label on your vehicle, always follow the instructions on the vehicle label.

If a label comes off or becomes illegible, contact your dealer to get a replacement. Replacement safety labels are available at no charge to you. The part number is provided in this manual, printed on the label, or can be provided by your dealer.

OPERATOR WARNING (P/N 695306)

Located on the dash to the left of the steering column.

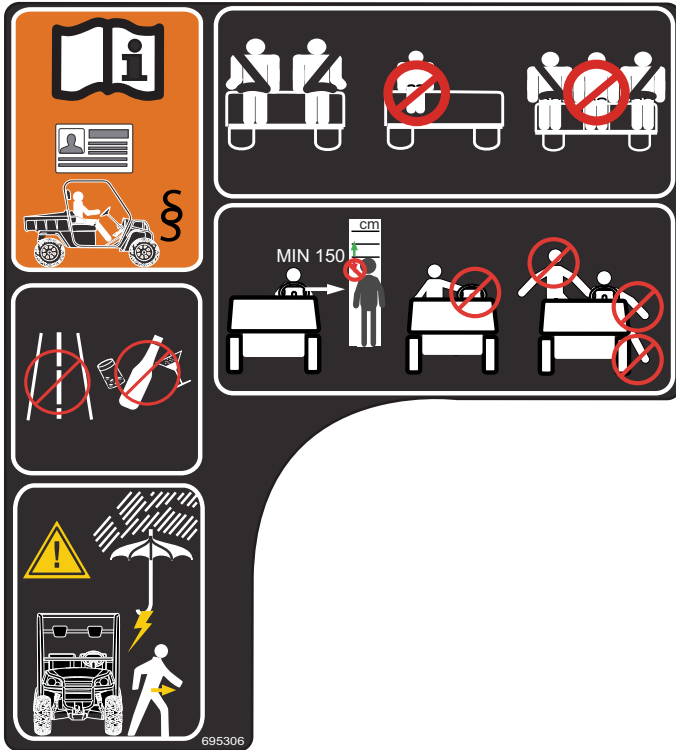

BATTERY WARNING (P/N 640561)

Located on the battery hold down.



REAR PASSENGER SAFETY WARNING (P/N 628943)

Rear passenger safety label located on the armrest of the rear seat.

⚠️ WARNING Failure to follow these instructions could result in **DEATH** or **SERIOUS INJURY**

- ALWAYS remain PROPERLY SEATED with SEAT BELT FASTENED and HOLDING ON.
- ONLY 2 occupants on bench seat.
- Children may need assistance to remain PROPERLY SEATED with SEAT BELT FASTENED and HOLDING ON. NEVER leave children unattended.
- KEEP feet, legs, hands and arms inside the vehicle at all times.
- NEVER attempt to enter or exit a moving vehicle.
- AVOID standing in front of or behind vehicle.



628943

LOAD DECK WARNING (P/N 630398)

Located on the underside of the rear seat bottom/load deck.

⚠️ WARNING Failure to follow these instructions could result in **DEATH** or **SERIOUS INJURY**

- Maximum deck load is 400 lbs. (181 kg)
- The center of gravity of the load must not exceed 12 inches (30 cm) above the deck floor.
- The load must be as far forward as possible and secured.
- Top heavy loads may cause vehicle instability or tip over.
- Drive slowly straight up or down slopes and in turns.
- NEVER allow passengers to ride on load deck.



630398

SEAT BELTS



Operating the vehicle while not wearing the seat belt increases the risk of serious injury or death in the event of rollover, loss of control, or sudden stopping.



All riders must wear seat belts at all times.

MAXIMUM CARGO LOAD / MAXIMUM WEIGHT CAPACITY



Exceeding the weight capacities can cause loss of vehicle control and possible injury or death.

Maximum Cargo Load (Flip Seat Load Deck)	400 lbs. (181 kg.)
Maximum Vehicle Weight Capacity	940 lbs. (426 kg)

- Do not exceed the maximum cargo load for any area of the vehicle.
- Do not exceed the maximum vehicle weight capacity (includes weight of operator, passengers, cargo and accessories).

TIRE PRESSURE



Improper tire pressure or uneven tire pressure can cause loss of vehicle control and possible injury or death.

Maintaining correct tire inflation pressure is essential for safe vehicle operation. Correct tire pressure for the front and rear tires is 12 psi (83 kPa).

OPERATOR SAFETY

Safe and responsible use of this vehicle is necessary to prevent dangerous conditions for the operator, passengers, and other people in the area of operation. This section of the manual provides information on the safe operation of the vehicle. Make sure you read, understand and comply with all of this information to decrease the risk of personal injury or death.



Serious injury or death can occur if you do not follow the instructions and procedures shown in this owner's manual.

- Read this entire manual and all product labels carefully. Follow the safety information and operating procedures described.
- Do not carry a passenger until you have a minimum of two hours driving experience on this vehicle.
- Keep feet, legs, hands, and arms inside the vehicle at all times.
- The driver must keep both hands on the steering wheel and both feet on the floor or pedals.
- Inspect the vehicle before each use to make sure it is in safe operating condition. Perform the pre-ride inspection described in this manual. See page 18.
- Always have the vehicle checked by an authorized dealer after an accident.
- Always turn the key switch to the OFF position and remove the key before you leave the vehicle.
- Remove the key when the vehicle is not in use to prevent accidental operation, unauthorized use by someone without a driver's license and proper training.

Additional information about safety is included throughout this manual or can be obtained from your local dealer.



Failure to operate this vehicle as instructed can cause collision, loss of control, or rollover resulting in severe injury or death. Follow all safety warnings in this section of the owner's manual. See the OPERATION section of the owner's manual for operating procedures and additional safety information.

Unauthorized Use

This vehicle is for adult use only. Any person who does not have a valid driver's license is not permitted to operate the vehicle.

Leaving the key in the key switch allows unauthorized use of the vehicle by an unlicensed driver. Always remove the key when the vehicle is not in operation.

Operating without Instruction



Operation of this vehicle without proper instruction increases the risk of an accident. The operator must understand how to operate the vehicle correctly in different situations and on different types of terrain.

All operators must read, understand and comply with the owner's manual and all warning and instruction labels before operating the vehicle.

Alcohol or Drugs



Operation of the vehicle during or after consuming alcohol or drugs can adversely affect operator judgment, reaction time, balance and perception.

Never drink alcohol or use drugs or medications before or during operation of the vehicle.

Seat Belts



Riding in this vehicle without wearing the seat belt increases the risk of serious injury in the event of rollover, loss of vehicle control, accident or, sudden stop. Seat belts can decrease the severity of injury in these circumstances.

The operator and passengers must wear seat belts at all times.

Passenger

Children may need assistance to remain properly seated with seat belt fastened.

Keep arms, hands, legs and feet inside the vehicle at all times.

BEFORE OPERATING

Perform the *Pre - Ride Inspection* on page 18 before each use to make sure the vehicle is in safe operating condition. Failure to inspect and confirm that the vehicle is safe to operate increases the risk of an accident.

Follow all inspection and maintenance procedures and schedules described in this owner's manual. See *Routine Maintenance* on page 27.

Load Operation

The weight of cargo and occupants affects vehicle operation. Carefully calculate how the vehicle is loaded and how to safely operate it. Follow the instructions in this manual for loading, tire pressure, and speed.

Do not exceed weight capacities specified for your vehicle. Capacities are listed in *Maximum Cargo Load / Maximum Weight Capacity* on page 8 of this manual, and also on the label affixed to the load deck. As passenger weight increases, cargo weight needs to be adjusted to ensure the maximum vehicle weight capacity is not exceeded.

See *Tire Pressure* on page 8 for pressure specifications.

Verify tire pressure, and drive slowly and carefully to maintain control of the vehicle if driving under any of the following conditions:

- passengers and/or cargo exceeds half the maximum weight capacity
- driving in rough terrain
- driving over obstacles
- towing
- climbing a hill

Driving in Reverse

Make sure the area behind the vehicle is clear before operating in reverse. After making sure it is clear and safe to operate in reverse, accelerate slowly. Avoid making sharp turns in reverse.

SAFETY

Driving a Damaged Vehicle

Driving a damaged vehicle is not safe.

If your vehicle has been involved in any type of accident, have it inspected by a qualified service provider to verify that it is safe for operation.

Driving at High Speeds

High speed operation increases risk of loss of control. Always drive at a speed that is appropriate for the terrain, visibility, operating conditions and your skill and experience level. Use the brake to control speed and maintain control of the vehicle.

Driving on Pavement

The tires on your are designed only for off road use; not for use on pavement. Driving the vehicle on paved surfaces can affect handling characteristics and increase tire wear.

If possible, avoid driving on paved surfaces. If unavoidable, drive slowly, travel short distances and avoid sudden turns or stops.

Driving on Public Roads

Driving your on public streets, roads or highways could result in a collision with another vehicle. Never drive this vehicle on any public street, road or highway, including dirt and gravel roads, unless they are designated for off road use. Most areas prohibit the operation of this vehicle on public streets, roads or highways, and can result in traffic violations and fines.

Turning

Improper or careless turning can cause loss of traction, loss of control, accident or rollover. Do not turn quickly or at sharp angles. Do not turn at high speeds. Practice turning at slow speeds before attempting to turn at faster speeds.

Jumps and Stunts

Attempting wheelies, jumps or other stunts increases the risk of an accident or rollover. Never attempt wheelies, jumps or other stunts. Avoid exhibition driving.

Unfamiliar Terrain

Drive slowly and cautiously on unfamiliar terrain to prevent an accident or rollover. Unfamiliar terrain can contain hidden rocks, bumps or holes that can cause loss of control or rollover. Constantly monitor for changing terrain conditions.

Obstacles

Check for obstacles before operating in an unfamiliar area. Do not drive over obstacles that are too large for the vehicle or your driving abilities.

Climbing Hills

Do not climb hills that are too steep for the vehicle or your driving abilities. Practice driving on small hills before attempting to drive on larger hills. Loss of vehicle control or rollover can result from climbing hills incorrectly.

Driving Downhill

Inspect the terrain before descending a hill. Avoid driving across hills. Use the brake to limit speed and maintain control. Loss of vehicle control or rollover can result from driving downhill incorrectly.

Stalling on a Hill

A rollover can result from stalling or rolling backward while climbing a hill. Drive uphill at a constant speed.

Parking on a Hill

Refer to *Parking the Vehicle* on page 20.

Tires

Operating the vehicle with incorrect tires or with incorrect or uneven tire pressure can cause loss of control or an accident. Always use the size and type tires specified for the vehicle. See *SPECIFICATIONS CHART* on page 43. Always maintain correct tire pressures as specified in *Tire Pressure* on page 8.

Slippery Terrain

Driving on rough, wet or loose terrain increases the risk of loss of traction or control, accident or rollover. Drive slowly and use correct turning procedures when operating on slippery surfaces.

Tires that have lost traction, and then regain traction suddenly, can cause loss of vehicle control or rollover.

Driving on Ice

Severe injury or death can result if the vehicle and operator fall through ice. Never operate the vehicle on a frozen body of water unless the ice is determined to be thick enough to support the weight and moving force of the vehicle, occupants, cargo and other vehicles operating in the same area.

Check with local authorities and residents to confirm ice conditions and thickness over your entire route. Operators assume all risk associated with frozen bodies of water.

Vehicle Lifting

The vehicle must be on a firm and level surface for lifting. Remain constantly aware that the vehicle is not stable during the lifting process. Do not get under a vehicle until you verify that it is stable on the jack stands. Never get under a vehicle while it is on a jack only. Put wheel chocks in front of and behind the wheels that are not being lifted. Do not allow anyone to remain or get on the vehicle at any time during the lifting process.

Read and comply with all warnings and follow the lifting procedures described on page 27.

Vehicle Modification

Do not install any accessory not approved by the manufacturer. Do not modify the vehicle to increase speed or power. Any modifications or installation of accessories not approved by the manufacturer, can create a safety hazard and increase the risk of injury.

The warranty will be terminated if the vehicle is modified to increase vehicle speed or power.

The warranty may be terminated if original (or equivalent) replacement parts are not installed on the vehicle.

The addition of some accessories can change the handling characteristics of the vehicle. Use only manufacturer approved accessories, and familiarize yourself with their function and effect on the vehicle.

FEATURES AND CONTROLS

GENERAL INFORMATION

NOTICE: If the vehicle is equipped with factory installed custom accessories, some accessories remain operational with the key switch in the 'OFF' position.

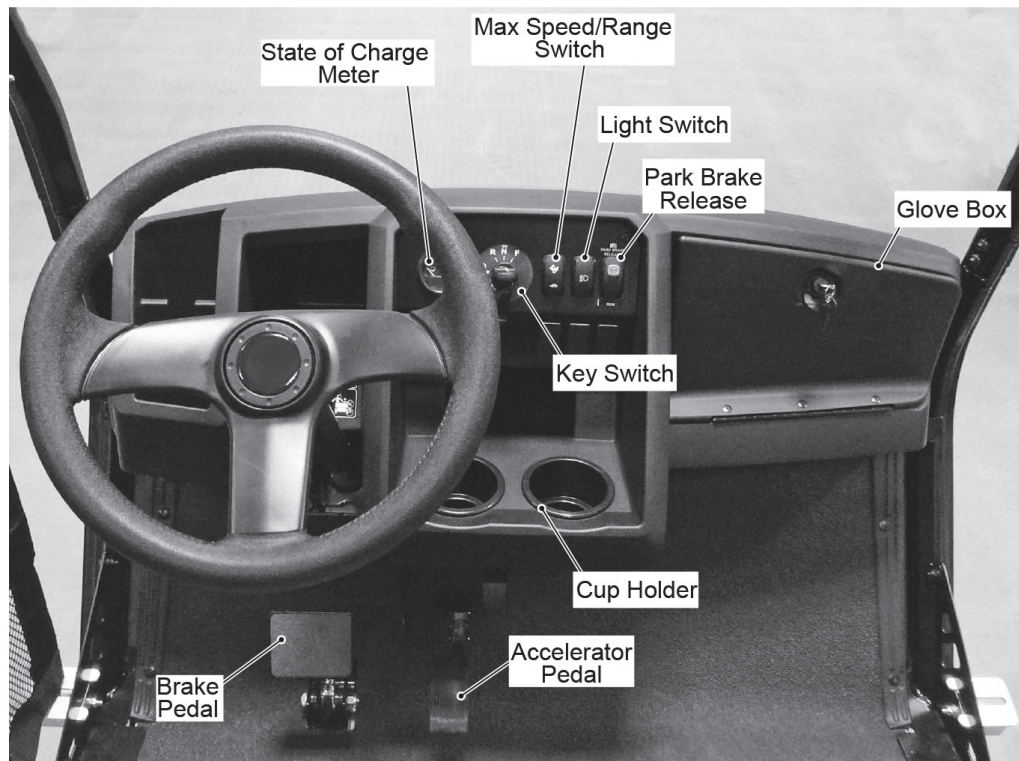

Key Switch / Direction Selector

Located on the dash to the right of the steering wheel, this is a four position switch. It allows the operator to turn the electrical system off completely by moving the key to the OFF position; or select Reverse, Neutral, or Forward by rotating the key. When the key is in the OFF position, the park brake will engage.

State of Charge Meter

The illuminated state of charge meter is located on the dash. It indicates the amount of usable power in the batteries, with 'F' indicating a full charge on the battery pack and 'E' indicating the batteries are low.

Light Switch

Located on the right side of the key switch, this ON/OFF switch controls the lights. In the ON position, the headlights and taillights illuminate.

Max Speed / Range Switch

This is a two position switch located on the dash to the right of the key switch.

The top position is the Max Speed setting. It allows the vehicle to travel up to 24.5 MPH. This setting diminishes distance capability for increased speed advantage.

The bottom position is the Max Range setting. It limits the top speed of the vehicle to 16 MPH, which conserves battery power in order to extend travel distance.

Auxiliary Switch Positions

There are three empty spaces on the dash to allow for additional switches to control added lights or accessories.

12 Volt Power Outlet

Located in the lower part of the dash above the cup holder, the 12 volt outlet supplies constant power for additional equipment equipped with a 12 volt plug.

NOTICE: Do not draw more than 10 AMPS through the 12V outlet.

Cup Holder

A cup holder is provided for convenience of vehicle occupants.

Accelerator Pedal

The accelerator pedal is located on the floorboard to the right of the brake pedal. Its function is to control the speed of the vehicle.

FEATURES AND CONTROLS

Brake Pedal

The brake pedal is located on the floor to the left of the accelerator pedal. The brake pedal function is to slow or stop the moving vehicle.

Park Brake

This vehicle is equipped with an IntelliBrake™ system on the motor. The park brake will automatically engage when the accelerator has been released and the vehicle drops below 2 MPH or the key switch is in the OFF position. See *Park Brake Release Switch* on page 21 for towing and loading information. For disengaging without motor power see *Emergency Park Brake Release* on page 21.

Charger Receptacle

The polarized receptacle for charging the batteries is located under the dash on the driver side. The cover must be opened to access the receptacle.

Taillights

The taillights are located in the rear fenders.

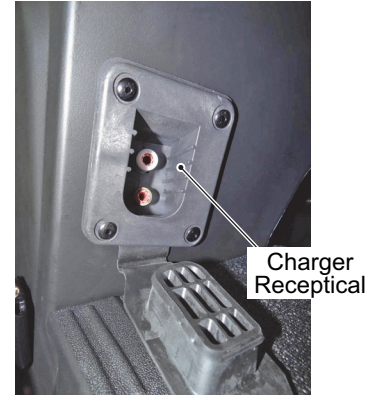

Side Nets

Side nets are a standard safety feature provided with the vehicle and must be properly secured before operating vehicle.

Seat Belts

The vehicle is equipped with seat belts for the driver and passengers. Seat belts must be worn at all times by all occupants when vehicle is in motion.

For more operational and safety information, see *Seat Belt Operation* on page 21.

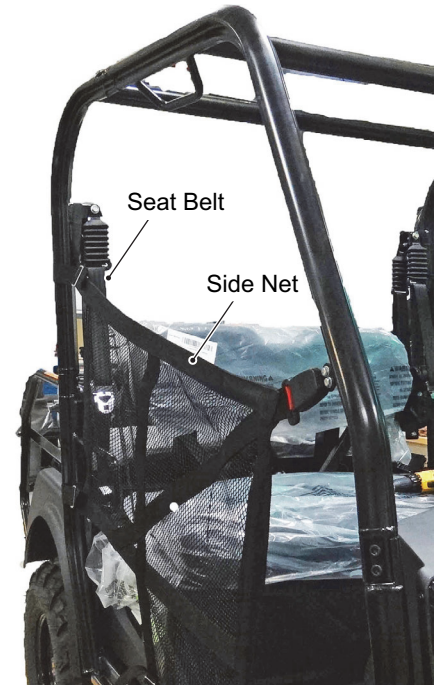

Rear Seat / Load Deck

The rear facing seat is designed for two occupants.

The rear seat can be converted to a load deck by unfolding the seat bottom.

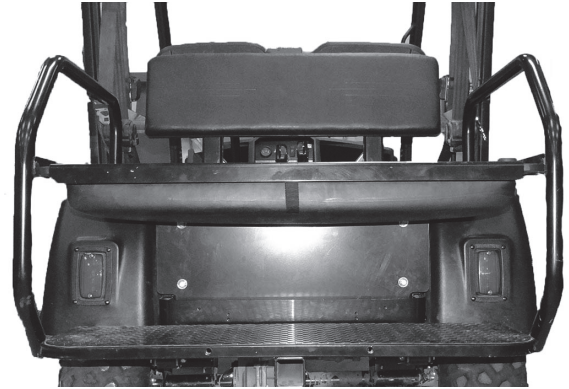

OPS / Top / Windshield

The standard vehicle is equipped with an OPS (Operator Protection System); vehicle may be equipped with an optional top, and/or windshield.

The OPS and top provide some protection from smaller falling objects, but will not protect against large falling objects such as trees or heavy limbs.

The windshield deflects oncoming wind from occupants, but will not protect against flying objects and tree limbs.

The top and windshield provide some protection from the elements; however, they will not keep occupants dry in a downpour.



The OPS and top do not provide protection from roll over or falling objects.

The windshield does not provide protection from tree limbs or flying objects.

Remove the windshield and store securely before transporting this vehicle on a trailer. The windshield is not designed to withstand highway speeds.

FEATURES AND CONTROLS

OPERATION

SAFETY

⚠ WARNING

Failure to operate the vehicle correctly can result in a collision, loss of control, accident or rollover, and cause serious injury or death. Read and comply with all safety warnings in the safety section of this owner's manual.

Improper use of this vehicle could result in severe injury or death. The vehicle is a light duty utility vehicle, NOT an All Terrain Vehicle (ATV).

Consider the terrain, traffic conditions, and the environmental factors which affect the terrain and the ability to control the vehicle.

Use extra care and reduced speed when driving on poor surfaces such as loose dirt, wet grass, or gravel.

Maintain a safe speed when driving up or down a hill. Use the brakes to control the speed when traveling down an incline. A sudden stop or change of direction may result in loss of control.

To prevent loss of control, do not move the direction selector while the vehicle is in motion. Moving the direction selector while vehicle is in motion will result in the park brake being engaged.

Slow down before and during turns. All turns should be made at reduced speed.

Do not drive through water that is more than 12 inches (30 cm) deep.

To prevent inadvertent movement when the vehicle is left unattended turn the key switch to the OFF position and remove key from the switch.

Always bring the vehicle to a complete stop before shifting the direction selector.

Do not take vehicle out of gear while in motion (coast).

Check the area behind the vehicle before operating in reverse.

All occupants must be seated with the seat belts fastened and the front side nets latched. Keep the entire body inside the vehicle and hold on to the handrails while vehicle is in motion.

This vehicle is not a toy and using it while engaging in horseplay is dangerous.

Plan carefully before using the vehicle to go significant distances over unfamiliar terrain. Remember that a one hour drive may take many hours to walk back should the batteries become discharged or should the vehicle become stuck on unsuitable terrain.

BEFORE INITIAL USE

NOTICE: Record the four digit key number and store it in a safe place. Individual keys can only be replaced if the key number is known. Without a key number the entire ignition switch will have to be replaced if keys are lost.

Make a note of the key number in the event that new keys must be ordered. The key number is stamped into the key.

The key number must match the number on the key switch.

Be sure you understand the vehicle, its equipment and how to use it safely. Read, understand and follow the safety and operation label on the dash panel. Although the vehicle has been designed to provide safe and reliable operation, maintaining good performance depends, to a large extent, on the operator.

Before a new vehicle is put into operation, the items shown in the **INITIAL SERVICE CHART** must be performed.



OPERATION

Initial Service Chart

Item	Service Operation
Battery Charger	Remove from vehicle and read the operating instructions.
Batteries	Charge, Batteries must be fully charged before initial use.
Seats	Remove the protective plastic covering.
Brakes	Check the operation; adjust if necessary. Check the hydraulic fluid level; add if necessary
Tires	Check the air pressure; adjust if necessary. See <i>Wheels and Tires</i> on page 29 for inflation recommendations.
Vehicle Inspection	Visually inspect the overall vehicle for leaks or damage that may have occurred during shipping. Inspect for loose hardware; tighten if necessary.

Pre - Ride Inspection

Inspect and verify that the vehicle is in safe operating condition before each use to decrease the risk of an accident. Check the items in the table to help ensure safe and reliable operation.

Item	Check
Brake system/pedal travel	Check for proper operation.
Brake fluid	Check for correct level.
Park	Ensure the vehicle does not roll when the key switch is in the OFF position.
Front suspension	Inspect. Lubricate if necessary. Check for loose or missing hardware.
Rear suspension	Inspect. Lubricate if necessary. Check for loose or missing hardware.
CV boots	Inspect for damage. Replace if necessary.
Steering	Check for smooth and free operation.
Tires	Check the condition and pressure.
Wheel hardware	Check for loose or missing hardware.
Frame hardware	Check for loose or missing hardware.
Battery	Check the battery charge level.
Switches and indicator lights	Check the operation.
Headlights	Check the operation.
Brake light / taillights	Check the operation.
Seat belts	Check the entire length of the belt for damage. Check the latch operation.
Side Nets	Inspect the side nets and latches for damage. Check for loose or missing hardware.

WARNING

Hydrogen gas is generated as a natural part of the lead acid battery charging process. A 4% concentration of hydrogen gas is explosive and could cause severe injury or death. Charging must take place in an area that is adequately ventilated (minimum of 5 air exchanges per hour).

To reduce the chance of battery explosion that could result in severe injury or death, never smoke around or charge batteries in an area that has open flame or electrical equipment that could cause an electrical arc.

Hydrogen gas is generated in the charging cycle of batteries and is explosive in concentrations as low as 4%. Because hydrogen gas is lighter than air, it will collect in the ceiling of buildings necessitating proper ventilation.

Five air exchanges per hour is considered the minimum requirement.

Never charge a vehicle in an area that is subject to flame or spark. Pay particular attention to natural gas or propane water heaters and furnaces.

PORTABLE CHARGER

WARNING

Use the portable charger **ONLY** on 72 volt battery systems. Other usage may cause personal injury and damage. Lead acid batteries may generate explosive hydrogen gas during normal operation. Keep sparks, flames, and smoking materials away from the batteries. Provide adequate ventilation during charging. Never charge a frozen battery. Study all of the battery manufacturers' specific precautions such as recommended rates of charge and removing or not removing cell caps while charging.

DANGER

Risk of electric shock. Connect the charger power cord to an outlet that has been properly installed and grounded in accordance with all local codes and ordinances. A grounded outlet is required to reduce the risk of electric shock – do not use ground adapters or modify the plug. Do not touch the uninsulated portion of the output connector or an uninsulated battery terminal.

Disconnect the AC supply before making or breaking the connections to the battery while charging. Do not open or disassemble charger. Do not operate the charger if the AC supply cord is damaged or if the charger has received a sharp blow, has been dropped, or is otherwise damaged in any way – refer all repair work to qualified personnel. Not for use by children.

The portable charger is shipped with the vehicle. Prior to the vehicle or charger operation, the charger **must** be removed from the vehicle. **A dedicated circuit is required for the charger.** Refer to the charger manual for appropriate circuit protection. For optimum performance and shortest charge times, place the charger in an area with adequate ventilation that is relatively free of dirt, mud, or dust. If the charger is operated in an outdoor location, rain and sun protection must be provided. The charger may get hot during operation and must be placed such that the risk of contact by people is reduced.

NOTICE: *Looping the DC cord through the steering wheel when charging serves as a good reminder to store the cord out of the way when finished with charging. The DC plug can be damaged by driving over or catching the cord on the vehicle when driving away.*

! WARNING

To reduce the possibility of a physical hazard that could result in an electrical shock or electrocution, be sure that the charger plug is not damaged and is inserted into a grounded receptacle.

An ungrounded electrical device may become a physical hazard that could result in an electrical shock or electrocution.

Using the Charger

Before use, read the charger manufacturer's operation manual that is supplied with the charger.

! WARNING

To prevent a physical hazard that could result in an electrical shock or electrocution, be sure that the charger plug is not damaged and is inserted into a grounded receptacle.

An ungrounded electrical device may become a physical hazard that could result in an electrical shock or electrocution.

The charger cord is equipped with a polarized connector that fits into a matching receptacle on the vehicle. The receptacle is located under the driver side dash of the vehicle.

Open the receptacle cover to access the receptacle. Always check to be sure the receptacle is free from dirt and debris before inserting the charger cord. Once charging is complete and the charger cord is removed, close the receptacle cover to prevent dirt and debris from entering the receptacle area.

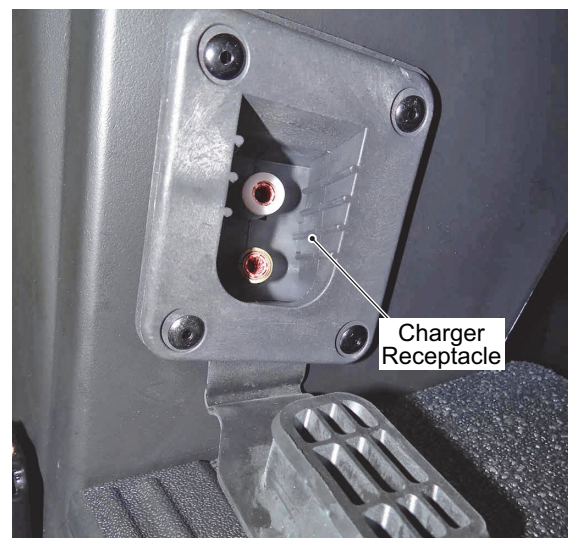

OPERATION

OPERATING THE VEHICLE

CAUTION

Improper use of the vehicle or the lack of proper maintenance may result in damage or decreased performance.

Read the following warnings before attempting to operate the vehicle.

WARNING

To reduce the possibility of severe injury or death resulting from the loss of vehicle control, the following warnings must be observed:

When driving the vehicle, consider the terrain, traffic conditions, and the environmental factors which effect the terrain and the ability to control the vehicle.

Use extra caution and reduce the speed when driving on poor surfaces, such as loose dirt, wet grass, gravel, etc.

Maintain a safe speed when driving down hill. Use the service brake to control the speed when traveling down an incline. A sudden stop or change of direction may result in the loss of control.

Slow down before and during turns. All turns should be made at reduced speed.

Never drive vehicle up, down, or across an incline that exceeds 14° (25% grade).

Do not permit more occupants on the vehicle than it is designed to carry. Refer to SPECIFICATIONS for the vehicle seating capacity.

To reduce the possibility of severe injury or death resulting from improper vehicle operation, the following warnings must be observed:

To prevent inadvertent movement when the vehicle is left unattended, engage the park brake by turning the key switch to the OFF position and remove the key from the switch.

Always bring the vehicle to a complete stop before shifting the direction selector.

Do not turn the key while in motion (coast). The parking brake will engage.

Check the area behind the vehicle before operating in reverse.

All occupants must be seated with seat belts fastened and the front side nets latched. Keep entire body inside vehicle and hold on to the handrails while the vehicle is in motion.

Key Switch Operation

When the key switch is rotated to the far left, the vehicle electrical system is off and not operational; the park brake is engaged in the OFF position. Rotate the key switch to the right to the first position, labeled R for reverse. The next position to the right, labeled N is neutral. Rotate to the far right position, labeled F, for forward.

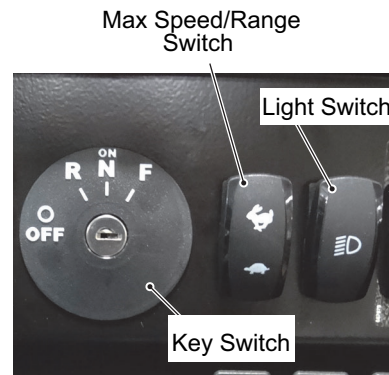

CAUTION

To prevent inadvertent operation of the vehicle when left unattended, the key should be turned to the OFF position and removed from the switch.

To reduce the possibility of component damage, the vehicle must be stopped completely before turning the key switch.

Parking the Vehicle

NOTICE: When parking the vehicle inside a garage or structure, the space must be well ventilated. Park the vehicle away from any source of flame or sparks, including any appliance with a pilot light.

Park the vehicle on a flat surface if possible. If parking on an incline is unavoidable, consider chocking the wheels as shown in the following illustration to keep the vehicle from rolling.

1. Press the brake to stop the vehicle.
2. Turn the key switch to the OFF position.
3. Remove the key from the ignition to prevent unauthorized use.
4. If parking on an incline, consider chocking the wheels on the downhill end as shown.

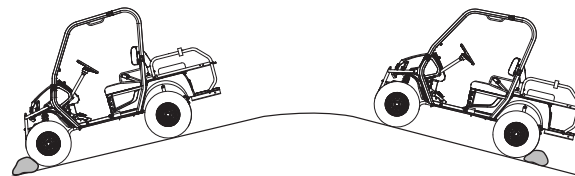

Park Brake Release Switch

This vehicle is equipped with an IntelliBrake™ parking brake that engages automatically. Keep the park brake release switch in the bottom position, labeled RUN, at all times except for when the vehicle needs to be towed. In the event the vehicle needs to be towed, park the vehicle on flat ground and slide the red locking feature on the switch down and rock the switch upward into the PARK BRAKE RELEASE position. This will allow the vehicle to free-wheel.



WARNING Switching the park brake release switch to PARK BRAKE RELEASE will release the park brake and allow the vehicle to freewheel. This may result in serious injury or death if performed on an incline. NEVER attempt to tow the vehicle without releasing the park brake.

Emergency Park Brake Release

If the park brake release switch does not deactivate the park brake or if the vehicle experiences a power failure you can release the park brake using the following steps. This method is for emergency purposes only, and should only be used if necessary.

NOTICE: Leaving the key engaged while the park brake is released for long periods of time will result in a complete discharge of the battery pack.

1. Chock the wheels so that the vehicle cannot roll.
2. Turn the key switch to the OFF position and remove the key.
3. Remove the seat bottom.
4. Locate the connectors labeled 1,2,3,4 zip tied to main wiring harness between the passenger side battery and the row of three batteries in the middle.
5. Disconnect both sets of connectors, and connect 1 to 3 and 2 to 4.
6. Insert the key and turn the key switch to the "N" position. This will release the park brake.
7. Carefully remove the wheel chocks in the direction the vehicle needs to be moved.
8. Turn the key switch to the OFF position once the car has been moved.
9. Disconnect both sets of connectors, and connect 1 to 2 and 3 to 4 returning the vehicle to normal operation.

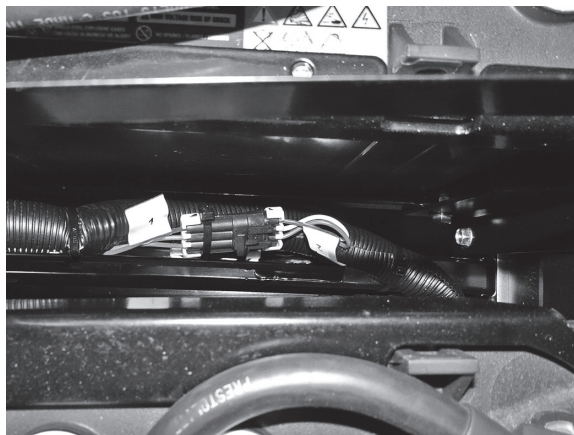

Front of Vehicle

Max Speed / Range Switch

Press the top of the switch to select the Max Speed setting. This setting allows the vehicle to travel up to 24.5 MPH while diminishing distance capability for increased speed advantage.

Press the bottom of the two position switch to select the Max Range setting. This setting limits top speed to 16 MPH, which conserves battery power in order to extend the distance the vehicle is capable of traveling before the batteries need to be recharged.

Light Switch Operation

Press the top of the two position switch to activate the headlights and taillights. Press the bottom of the switch to turn them off.



Brake Operation

This vehicle is equipped with four wheel hydraulic brakes. Press the brake pedal to control the speed or bring vehicle to a stop.

Accelerator Operation

With the key switch in the forward (F) or reverse (R) position, pressing the accelerator pedal starts the electric motor and activates the vehicle. When the pedal is released, the motor deactivates and the vehicle will decelerate. Press the brake pedal to stop the vehicle more quickly.

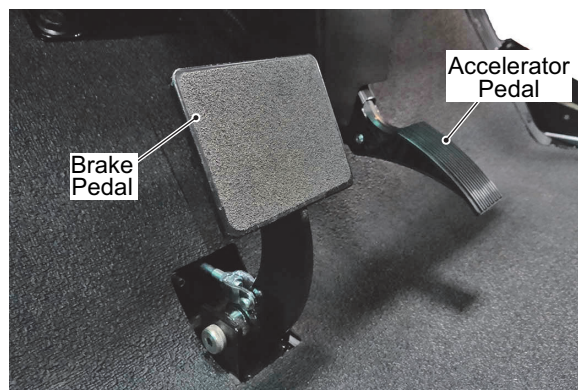

OPERATION

Seat Belt Operation

WARNING

Seat belts must be worn by all occupants whenever the vehicle is in motion.

Make sure seat belts are free from twists and that they latch securely.

Position the shoulder belt across the top of the shoulder; do not place the shoulder belt under the arm.

Keep the lap belts snug and positioned low on hips. Loose fitting belts significantly reduce protection.

The vehicle is equipped with seat belts for the number of occupants it is designed to carry; do not exceed the recommended number of occupants for the vehicle.

Seat belts are designed for one occupant per belt. Do not attempt to secure more than one person in a seat belt.

Seat belts must be worn at all times by all occupants when vehicle is in motion.

To keep the seat belts in proper working condition, do the following:

- Inspect the seat belt webbing and hardware periodically. Check for cuts, frays or loose parts. Replace components if excessive wear or damage is noticed.
- Keep seat belts clean and dry. To clean, use mild soap and warm water. Do not use bleach, dye, or abrasive cleaners as this will weaken the belt webbing material.
- Do not insert any foreign objects into the retractor mechanism.
- Periodically check for smooth operation and replace if the mechanism is not operating properly.

To properly secure the seat belts:

1. Pull the metal tab on the seat belt across the body toward the appropriate buckle located near the center of the seat.
2. Insert the metal tab into the buckle. (A click will be heard when the metal tab is securely latched).
3. Position the lap belt as low as possible on the hips, not at the waist.
4. Adjust to ensure a snug fit by pulling the shoulder portion upward.

The retractor will lock the belt during sudden stops. It may also lock if occupant leans forward quickly. Slow, easy motions allow the belt to travel freely.

To release the safety belt, press the buckle release button and allow the belt to retract. If the belt does not retract, check for a twist in the belt.

Common Sense Operation

WARNING

Never transport loaded firearms on or in the vehicle.

Check that firearms are unloaded with the safety engaged and are properly secured with the muzzle pointing in a safe direction before operating vehicle. Be aware of other firearms in the proximity to the operator and passengers.

This vehicle is not a toy. If not operated properly and responsibly, it can cause severe injury or death to the operator, passengers or bystanders. All operators should possess a valid driver's license. Children should not be permitted to operate the vehicle. Children may not have the skill, judgment or strength to operate this or similar vehicles.

Alcohol, drugs and many over the counter medications reduce the ability of the driver to operate the vehicle safely. Always review side effects of any medication with a doctor or pharmacist before operating the vehicle.

Protective clothing and an approved motorcycle helmet are recommended for the operator and passengers when operating the vehicle in rough or densely wooded terrain.

Vehicle stopping distance will increase when driving at full speed on a dirt road, loose surfaces, or wet grass. If the vehicle is fully loaded, it requires longer to stop than with no load. When operating the vehicle in wet weather conditions, remember that the brakes may need to be **lightly** applied in order to provide enough friction to dry the brake unit. If wet, the brakes lose much of their effect.

Slow down when on unfamiliar terrain. Slow down when cresting a hill in an area that is not familiar.

Some hills are too steep to climb. If attempting to climb a hill that is too steep or if unable to achieve adequate traction, **do not attempt to turn around on the hill. Slowly back straight down the hill using the brake pedal to control the speed.**

Environmental Concerns

WARNING

As a responsible user, practice respect for all wildlife and their habitat. Respect private property and comply with all local laws and regulations governing the use of light duty utility vehicles. To prevent severe injury or death while driving, always remain aware of environmental hazards such as steep slopes, overhanging limbs, etc.

Starting and Driving

- Make sure that the accelerator pedal is NOT pressed (no pressure on it).
- Place key in switch and turn the key switch to the desired position.
- Press the accelerator pedal to move the vehicle.

Make sure the key switch is in the OFF position and the key is removed from the switch before exiting the vehicle.

This vehicle is to be operated by licensed drivers only.

Do not attempt to operate the vehicle while under the influence of drugs or alcohol.

Never turn the key switch to OFF while the vehicle is in motion; doing so can cause loss of control and lead to serious injury or death.

On a downhill slope, it is possible for the vehicle to achieve speeds greater than if it were operating on flat terrain. Limit downhill speed to 5 mph (8 kph) with use of the brake pedal.

Always use caution on an uphill slope and the speed should be limited to no more than 5 mph (8 kph).

Loss of control may occur, possibly causing serious injury or death if the vehicle travels too fast on an uphill or downhill slope.

Use caution when traveling through water and never operate the vehicle in water over 12 inches (30 cm) deep.

Starting the Vehicle on a Hill



Do not attempt to hold the vehicle on hill by using the pressing the accelerator slightly. This will cause premature and excessive wear to drivetrain components.

To reduce the possibility of permanent damage to the drive system, it is important to prevent excessive roll-back when starting the vehicle on a hill. Press the accelerator with the right foot while releasing the brake pedal.

Coasting



To reduce the possibility of severe injury or death from coasting above recommended speeds, limit the speed with the brake pedal.

On steep hills, it is possible for the vehicle to coast at greater speeds than possible on a flat surface. To reduce the possible loss of vehicle control and severe drivetrain damage, speeds should be limited to no more than the maximum governed speed on level ground (see SPECIFICATIONS). Limit speed by applying pressure to the brake pedal.

Towing a Trailer

The vehicle is equipped with a 2-inch receiver. The trailer and its load must not exceed 1000 lbs (454 kg) and no more than 100 lbs (46 kg) tongue weight may be attached to the hitch. Remember that the overall capacity of the vehicle, operator, passenger, contents of load bed, and accessories must be reduced to compensate for the trailer and load.

The range of motion of the trailer is limited by the ball and hitch. The trailer should not be used on rough trails or over objects such as logs, large rocks, holes, etc.

Never install baskets or extensions using the hitch receivers. Such items will change the performance characteristics of vehicle and result in unsafe handling, possible roll over or vehicle damage.

Terrain

The vehicle is NOT designed for use on public roads. The vehicle may be used on established trails or open terrain that is free from stumps, large rocks, or holes. The vehicle should not be used to cross water that is more than 12 inches (30 cm) deep or fast moving water.

Be aware of steep slopes and overhanging limbs.

When traveling up or down steep slopes, do not attempt to turn the vehicle around on the slope.

Be aware that vehicle stopping distance increases when driving on wet grass, dirt roads, or loose surfaces.

Rear Facing Seat/Load Deck



Do not allow passengers to ride on load deck. Severe injury or death could result if a passenger should fall out, if the vehicle is involved in an accident, or if the vehicle makes a sudden maneuver.

The rear facing seat will accommodate two passengers with a combined weight of less than 400 lbs (181 kg). Seat belts are available for passengers on the rear facing seat and should be used according to *Seat Belt Operation* on page 22.

The seat bottom can be folded out to form a load deck. When using the load deck, position the load as far forward as possible and securely fasten it down. The maximum load is 400 lbs (181 kg) and the center of gravity must not be higher than 12" (30 cm) above the load deck.

WINCH OPERATION

This vehicle may be equipped with an optional winch. Read, understand and follow all of the information supplied with the winch on the operation and use of the winch before attempting to operate it.

Winch Application

A winch may be used for a number of purposes, including pulling the vehicle if it loses traction on unsuitable terrain.



Improper use of the winch could result in a number of conditions that could cause severe injury or death to the operator, occupants of vehicle or, bystanders.

It is impossible to predict all conditions for which the winch could be used, therefore the following warnings should not be considered as complete. Consider the possible dangers and take precautions to protect yourself, your passenger, and any bystanders before operating the winch.

⚠ WARNING

To prevent severe injury or death to the operator, occupants, or bystanders, consider the following when selecting an object to attach the cable to:

Make sure the object cannot be toppled or otherwise damaged.

The object that the winch cable is attached to could fall on the vehicle and it's occupants.

If attaching the winch to a dead tree, a section could fall.

When pulling the vehicle with the winch, pull straight only. Do not permit cable to contact the side of the drum.

Do not pull vehicle at an angle. If the vehicle is pulled at an angle, it could turn over causing severe injury or death to anyone in the area. The winch cable could also become overstressed and break causing severe injury or death to anyone struck by the cable.

To prevent severe injury or death, read and understand the following warnings before attempting to use the winch:

The winch is not intended to be used in any hoisting operation.

The rolling load capacity of the winch decreases with the steepness of the slope.

The winch is designed for intermittent duty only.

The electric motor should not be allowed to become excessively hot. If the motor becomes uncomfortably hot to the touch, stop winching and allow the motor to cool.

Always wear thick leather gloves when handling the wire cable.

Replace frayed wire cable with a direct factory replacement only.

Never operate the winch with less than five (5) full turns of cable around the drum.

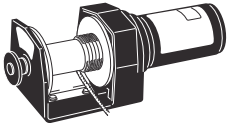

If the winch motor stalls from overloading, do not continue to activate the winch remote control. The wire cable may become overstressed.

Do not attempt to pull loads exceeding the manufacturers maximum load rating.

Have all persons and pets leave the area while operating the winch. Never allow anyone to remain in the vehicle.

To prevent damage to the wire cable, never hook the cable to itself. Always use a nylon sling.

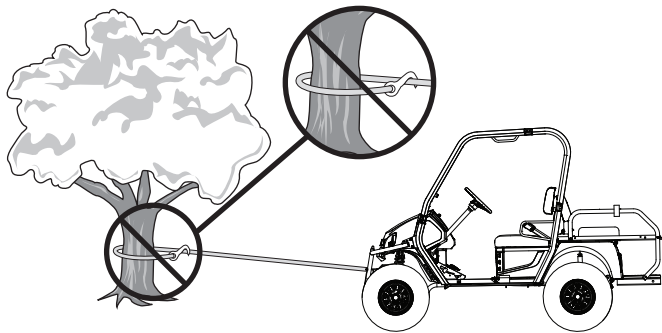

Do Not Hook Cable to Itself

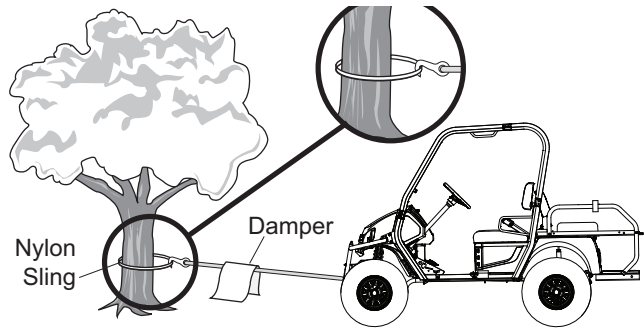

Use a Nylon Sling and Install a Damper when Winching

Stay clear of the winch, the cable and the cable hook. Place a heavy cloth, jacket, or blanket over the cable to act as a damper should the cable break when operating the winch.

When operating the winch, keep the entire area in view.

Never release the free spool clutch while the cable is under a load.

Never work around the winch drum or the winch cable while it is under tension.

Unplug the winch switch before working on the winch drum in order to prevent inadvertent operation.

When operating the winch, take up slack slowly. Stop the winch before the cable becomes tight and inspect all winching connections. Check the winch attachment, hook attachment, nylon sling (if required), and load attachment.

Do not pull at an angle. This will cause the wire cable to pile up on one end of the winch. This may jam the winch causing damage to the cable and/or the winch.

Pulling the vehicle at an angle can cause damage to the front suspension and may cause the vehicle to overturn. When pulling the vehicle, pull straight only.

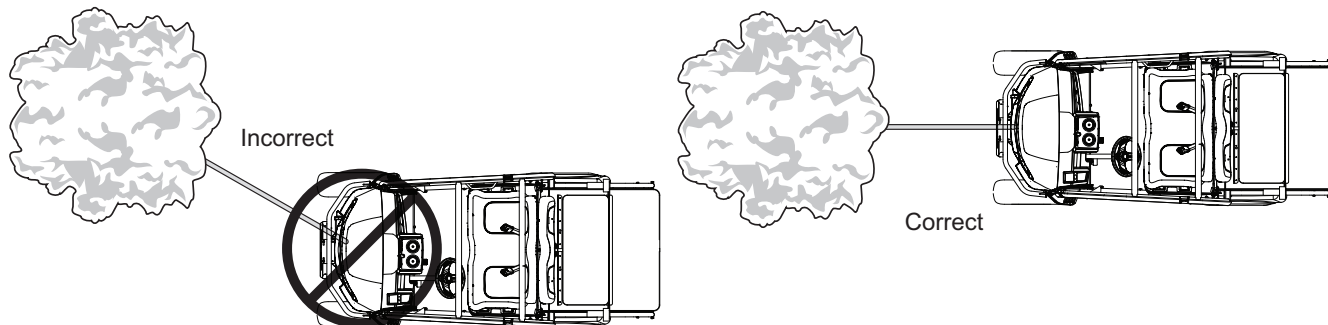

Do Not Pull at Angle

If the vehicle is being used as an anchor to winch a load, the parking brake should be applied and chocks installed on all wheels.

Never use the winch to lift people or other overhead loads.

Do not use the winch to secure loads. Use a tie down designed for the job.

Do not apply shock loads to the winch.

Do not attempt to modify or weld the winch.

MAINTENANCE

VEHICLE CLEANING AND CARE

WARNING

To reduce the possibility of severe injury or vehicle damage, read and understand all instructions supplied by manufacturer of the pressure washer.

CAUTION

When pressure washing the exterior of the vehicle, do not use pressure in excess of 700 psi and maintain a 12" minimum distance from the spray nozzle to the painted surface. To reduce the possibility of cosmetic damage, do not use any abrasive or reactive solvents to clean plastic parts.

It is important that proper techniques and cleaning materials be used. Using excessive water pressure may cause severe injury to the operator or bystanders, damage to seals, plastics, seat material, body finish, or electrical system. Do not use pressure in excess of 700 psi to wash the exterior of the vehicle.

Clean the windshield with lots of water and a clean cloth. Minor scratches may be removed using a commercial plastic polish or Plexus® plastic cleaner available from the service parts department.

Normal cleaning of vinyl seats and plastic or rubber trim requires the use of a mild soap solution applied with a sponge or soft brush and wipe with a damp cloth.

Removal of oil, tar, asphalt, shoe polish, etc. will require the use of a commercially available vinyl/rubber cleaner.

The painted surfaces of the vehicle provide an attractive appearance as well as durable protection. Frequent washing with lukewarm or cold water and a mild detergent is required to preserve the painted surfaces.

Occasional cleaning and waxing with non-abrasive products designed for 'clear coat' automotive finishes will enhance the appearance and durability of the painted surfaces.

Corrosive materials used as fertilizers or dust control can collect on the under-body of the vehicle. These materials will cause corrosion of under-body parts unless flushed occasionally with plain water. Thoroughly clean any areas where mud or other debris can collect. Sediment packed in closed areas should be loosened to ease its removal, using caution not to chip or otherwise damage paint.

ROUTINE MAINTENANCE

Preventive maintenance, applied at recommended intervals, is the best guarantee for keeping the vehicle dependable.

This vehicle will give years of satisfactory service, providing it receives regular maintenance. Refer to the PERIODIC SERVICE SCHEDULE for appropriate service intervals.

LIFTING THE VEHICLE

TOOLS

- Floor Jack
- Jack Stands
- Wheel Chocks

WARNING

To reduce the possibility of severe injury or death from a vehicle falling from a jack:

Always place chocks in front of and behind the wheels not being raised.

Be sure the vehicle is on a firm and level surface.

Never get under a vehicle while it is supported only by a jack.

Use jack stands and test the stability of the vehicle on the stands.

Use extreme caution since the vehicle is very unstable during the lifting process

CAUTION

When lifting the vehicle, position the jack and jack stands at the areas indicated.

Remove the payload from vehicle before lifting. No one should be in or on the vehicle while lifting.

MAINTENANCE

Lift Entire Vehicle

1. Place wheel chocks in front of and behind each front wheel.
2. Center the jack under the rear axle tube next to the differential housing or under the skid plate.
3. Raise the vehicle and position the jack stands under the frame where the leaf spring mounting bracket is welded to the frame.
4. Lower the jack and test the stability of the vehicle on the two jack stands.
5. Place the jack under the front-center of the car just behind the bumper.
6. Raise the vehicle and position the jack stands under the frame where the instrument panel support is attached to the frame.
7. Lower the jack and test the stability of the vehicle on all four jack stands.

Lift Front of Vehicle

1. Place wheel chocks in front of and behind the rear wheels.
2. Place the jack under the front-center of the car just behind the bumper.
3. Raise the vehicle with jack and position the jack stands under the frame where the instrument panel support is attached to the frame.
4. Lower the jack and test the stability of the vehicle on the jack stands.
5. The jack may be left under the front-center of the frame while the front end of the vehicle is on the jack stands.

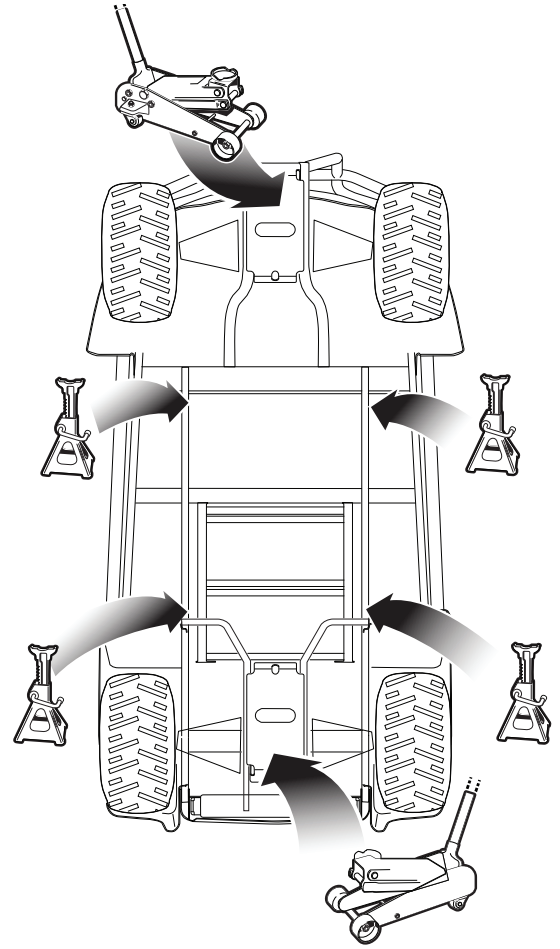

Lift Rear of Vehicle.

1. Place wheel chocks in front of and behind the front wheels.
2. Place the jack under the rear-center of the car on the skid plate covering the rear differential.
3. Raise the vehicle with the jack and position the jack stands under the frame where the leaf spring mounting bracket is welded to the frame.
4. Lower the jack and test the stability of the vehicle on the two jack stands.
5. The jack may be left under the rear skid plate while the rear end of the vehicle is on the jack stands.

Lower Vehicle

Lower the vehicle by reversing the lifting sequence.

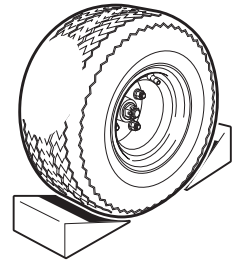

LIGHT BULB REPLACEMENT

Headlight Bulb

The headlight contains an LED light board rather than a light bulb. If the LEDs burn out, the whole light must be replaced.

Taillight Bulb

The taillight contains an LED light board rather than a light bulb. If the LEDs burn out the whole light will have to be replaced.

WHEELS AND TIRES



A tire explosion can cause severe injury or death. Never exceed the inflation pressure rating on the tire sidewall.

To reduce the possibility of tire explosion, pressurize the tire with small amounts of air applied intermittently to seat the bead. Due to the low volume of the small tires, over-inflation can occur in seconds. Never exceed the tire manufacturer's recommendation when seating a bead. Protect the face and eyes from escaping air when removing a valve core.

Use caution when inflating the tires. Over-inflation could cause the tire to separate from the wheel or cause the tire to explode, either of which could cause severe injury.

To reduce the possibility of severe injury caused by a broken socket when removing the wheels, use only sockets designed for impact wrench use.

Tire Repair

TOOLS

- Lug Wrench, 3/4"
- Impact Socket, 3/4"
- Impact Wrench
- Torque Wrench, ft. lbs.

Generally, the most cost effective way to repair a flat tire resulting from a puncture in the tread portion is to use a commercial tire plug.

If the tire is flat, raise the vehicle and remove the wheel. Refer to 'Lifting the Vehicle' for proper lifting procedure and safety information. Inflate the tire to the maximum recommended pressure, immerse tire in water to locate the leak and mark the leak with chalk. Insert the tire plug in accordance with the manufacturer's specifications.

Use caution when inflating the tires. Due to the low volume of the small tires, over-inflation can occur in seconds. Over-inflation could cause the tire to separate from the wheel or cause the tire to explode.

The recommended tire inflation pressure is 12 psi. Under no condition should the inflation pressure be higher than recommended on the tire sidewall. All four tires should have the same pressure for optimum handling characteristics. Be sure to install the valve stem dust cap after checking or inflating the tire. The vehicle is fitted with low volume tubeless tires mounted on one piece rims.

Wheel Installation



To reduce the possibility of component damage, do not tighten the lug nuts to more than 75 ft. lbs. (101 Nm) torque.

NOTICE: Follow the cross sequence pattern shown when installing the lug nuts to ensure even seating of the wheel against the hub.

With the valve stem to the outside, mount the wheel onto the hub with lug nuts. Finger tighten the lug nuts (1) in a 'cross sequence' pattern. Tighten the lug nuts to 65 to 75 ft. lbs. (88 to 101 Nm) torque in 20 ft. lbs. (27 Nm) increments following the 'cross sequence' pattern.

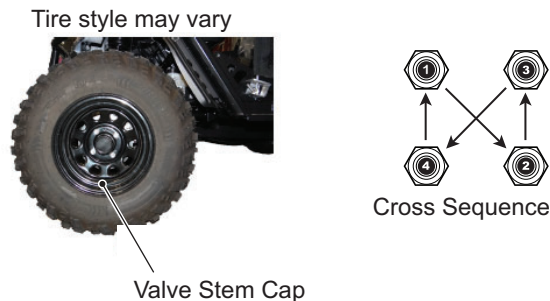

MAINTENANCE

WHEEL ALIGNMENT

Driving over rough terrain may cause misalignment of the wheels. With the four wheel independent suspension both the front and rear wheels may need to be aligned.

TOOLS

- Tape Measure
- Open End Wrench, 12mm
- Open End Wrench, 17mm
- Open End Wrench, 19mm

Park the vehicle on a level surface, set the front wheels straight ahead. Turn the key switch to the OFF position and remove the key.

With the vehicle empty (no passengers or payload) measure the distance between the center of the front set of tires. Measure both in front of and behind the front tires, keeping the tape measure parallel to the ground. The measurement behind the tires should be 0" to 1/8" more than the measurement taken at the front of the tires to produce a toe-in condition.

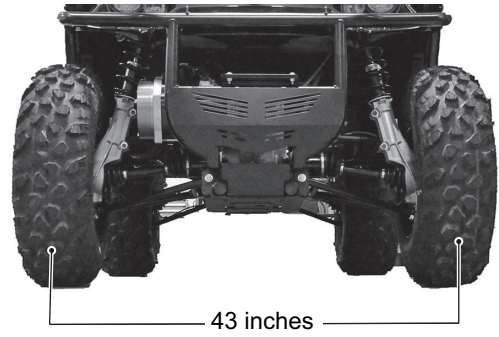

Front

Adjust both tie rods equally to obtain the correct amount of toe-in. Hold the tie rod (2) with an open end wrench, loosen the jam nut (1), and turn the adjustment shaft (3) to move the wheel in the desired direction.

Recheck the measurement at the front and at the rear of the front tires, if the 0" to 1/8" toe-in has been achieved tighten the lock nut (1) on each tie rod.

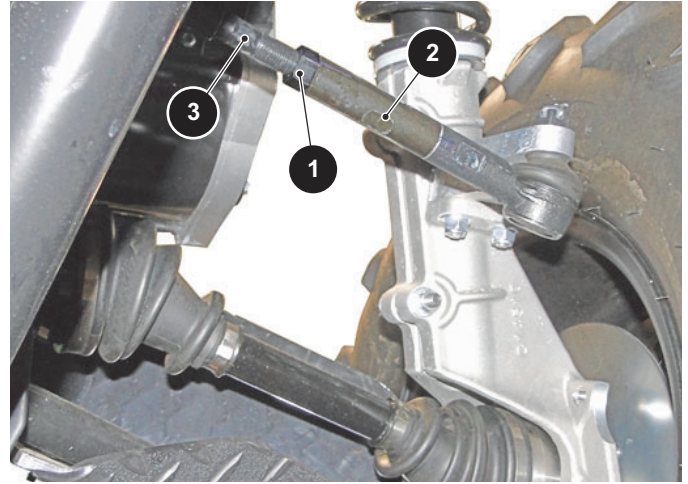

Rear

The rear tie rods have jam nuts (4) at each end, one end has the standard right hand threads and the other end has left hand threads.

Loosen the jam nuts (4) on both tie rods, turn the center tube (5) with an open end wrench to adjust the length of each tie rod equally.

Recheck the measurement at the front and at the rear of the rear tires, if the 0 to 1/8" toe-in has been achieved tighten the lock nuts (4) on each tie rod.

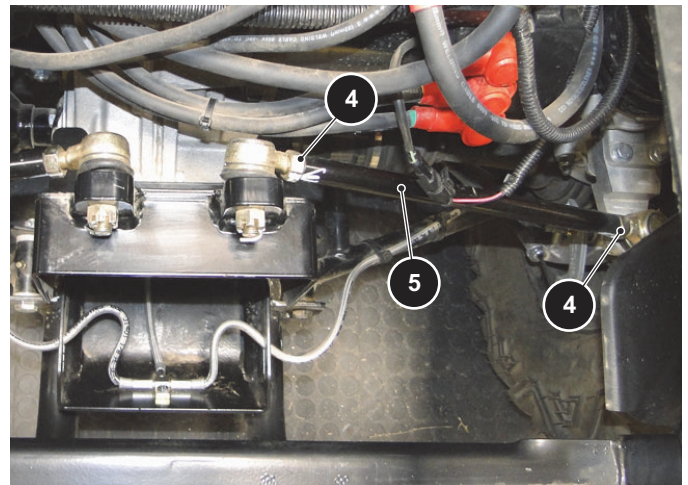

BRAKES

This vehicle is equipped with four wheel hydraulic disc brakes and a motor brake. Check the fluid level at intervals specified in the PERIODIC SERVICE SCHEDULE. If fluid leaks are noticed or the brake pedal seems soft, check the fluid level immediately. If the brake pedal is soft, the brake system should be bled to remove air from the brake lines. Refer to *Bleeding Brakes* on page 29 for procedure.

Master Cylinder

The master cylinder is located behind the driver side front wheel, mounted to the frame. Before removing the reservoir cap, clean any dirt or debris from around the reservoir and cap. Remove the cap and check that the fluid level is between the MIN and MAX fill lines. Add DOT 3 brake fluid if necessary. Check for leaks and all fitting connections.

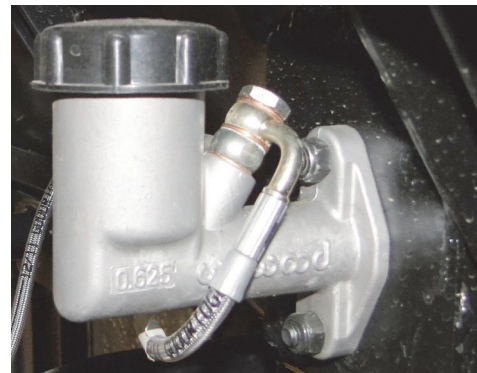

Bleeding Brakes

TOOLS

- Hose
- Brake Fluid, DOT 3
- Clean Container
- Wrench, 1/4" box end

The hydraulic brake system must be free of air to operate properly. Air can enter the system when hydraulic parts are disconnected for servicing or replacement, or when the fluid level in the master cylinder reservoir is very low. Air in the system will give the brake pedal a spongy feeling when pressed.

NOTICE: An assistant is necessary to perform this procedure.

1. Use a clean cloth to wipe off the master cylinder reservoir and caliper bleeder valves. Clean each fitting before opening to prevent contaminating the system.
2. Open the master cylinder reservoir and top it off with standard automotive DOT 4 brake fluid.



Never return the brake fluid to the original container or reuse the brake fluid due to the possibility of contamination by dirt, grease, and moisture. Contaminated brake fluid could cause failure of the braking system. Dispose of the brake fluid in accordance with Federal, state, and local codes.

3. Attach a short length of clear hose to the caliper bleeder valve and insert the other end into a suitable clean container containing fresh, clean brake fluid.

NOTICE: Check the fluid level in the master cylinder frequently during this operation to prevent air from entering the lines.

4. Start with the passenger side rear brake, then the driver side rear brake, passenger side front brake and finish with the driver side front brake. Bleeding the brakes requires an assistant to pump the brake pedal and keep pressure on the pedal. Bleed the brakes using the following procedure:
 - a. Build pressure in the brake system, if possible, by slowly pumping the brake pedal.
 - b. Open the bleeder valve while an assistant holds pressure on the brake pedal as the pedal slowly goes through the full stroke.
 - c. Close the bleeder valve and have the assistant slowly release the brake pedal.
 - d. Repeat the process until no bubbles can be seen leaving the bleeder valve.
 - e. Close the valve and move to the next brake.

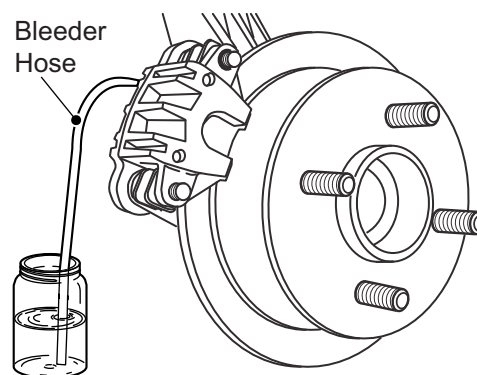

MAINTENANCE

POWERTRAIN

WARNING

To reduce the possibility of severe injury or death from improper servicing techniques:

DO NOT attempt any type of servicing operations before reading all notes, cautions and warnings in this manual.

Any service requiring adjustments to the powertrain while the motor is running must be made with all four drive wheels raised and the vehicle properly supported on jack stands.

To reduce the possibility of motor damage, never operate the vehicle at full throttle for more than 4 - 5 seconds while the vehicle is in a 'no load' condition.

Reduce the possibility of accidental starting by disconnecting the battery at the negative terminal before servicing.



Wear eye protection when working on the vehicle. Use extra caution when working around the batteries or using solvents or compressed air.

To reduce the possibility of causing an electrical arc, which could result in a battery explosion, turn off all electrical loads from the battery before removing the battery wires.



Wrap wrenches with vinyl tape to reduce the possibility of a dropped wrench 'shorting out' a battery which could result in an explosion.

The electrolyte in a battery is an acid solution which can cause severe burns to the skin and eyes. Treat all electrolyte spills to the body and eyes with extended flushing with clear water. Contact a physician immediately.

Any electrolyte spills should be neutralized with a solution of 2 teaspoons (10 ml) sodium bicarbonate (baking soda) dissolved in 1 quart (1 liter) of water and then flushed with clean water.

Aerosol containers of battery terminal protectant must be used with extreme caution. Insulate the metal container to reduce the possibility of the can contacting any battery terminals which could result in an explosion.

It is in the best interest of both the vehicle owner and the service technician to carefully follow the procedures recommended in this manual. Preventative maintenance, applied at the recommended intervals, is the best guarantee for keeping the vehicle both dependable and economical.

This vehicle will give years of satisfactory service, providing it receives regular maintenance. Refer to the PERIODIC SERVICE SCHEDULE for appropriate service intervals.

CAUTION

To prolong the vehicle life, some maintenance items must be serviced more frequently on vehicles used under severe driving conditions such as extreme temperatures, extreme dust/debris conditions, or frequent use with a maximum load.

AXLES

Front and Rear Axles

The only maintenance required for the first five years is the periodic inspection of the axles for lubricant leakage. Unless leakage is evident, the lubricant need only be replaced after five years. Refer to the Repair Manual for the fluid replacement procedure.

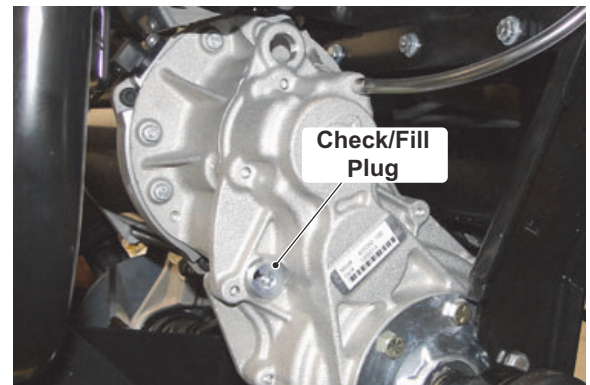

BATTERY CHARGING AND MAINTENANCE

Battery Safety

Always observe the following warnings when working on or near batteries.



To prevent a battery explosion that could result in severe personal injury or death, keep all smoking materials, open flames, and sparks away from the batteries.

Hydrogen gas is formed when charging batteries. Do not charge the batteries without adequate ventilation. A 4% concentration of hydrogen gas is explosive.

Be sure that the key switch is in the off position and all electrical accessories are turned off before beginning service on the vehicle.



Never disconnect a circuit under load at a battery terminal.



Batteries are heavy. Use proper lifting techniques to move them. Always lift the battery with a commercially available battery lifting device. Use care not to tip the batteries when removing or installing them; spilled electrolyte can cause burns and damage.

Electrolyte in a battery is an acid solution which can cause severe burns to skin and eyes. Treat all electrolyte spills to the body and eyes with extended flushing with clear water. Contact a physician immediately.



Always wear a safety shield or approved safety goggles when adding water or charging batteries.

Neutralize electrolyte spills with a solution of 1/4 cup (60 ml) sodium bicarbonate (baking soda) dissolved in 1-1/2 gallons (6 liters) of water then flush with clean water.

Overfilling the batteries may result in the electrolyte being spilled from the battery during the charge cycle. Expelled electrolyte may cause damage to the vehicle and storage facility.

Aerosol containers of battery terminal protectant must be used with extreme caution. Insulate the metal container to prevent the can from contacting the battery terminals which could result in an explosion.

Use insulated wrenches to prevent the possibility of a dropped wrench from shorting out a battery which could result in an explosion and severe personal injury or death.

Battery Disposal

Lead-acid batteries are recyclable. Return whole scrap batteries to the distributor, manufacturer or lead smelter for recycling. For neutralized spills, place the residue in acid-resistant containers with absorbent material, sand, or earth and dispose of it in accordance with local, state, and federal regulations for acid and lead compounds. Contact the local and/or state environmental officials regarding disposal information.

Battery

A battery is defined as two dissimilar metals immersed in an acid. If the acid is absent or if the metals are not dissimilar, a battery has not been created. The batteries most commonly used in these vehicles are lead acid.

A battery does not store electricity, but is able to produce electricity as the result of a chemical reaction which releases stored chemical energy in the form of electrical energy. The chemical reaction takes place faster in warm conditions and slower in cold conditions. Temperature is important when conducting tests on a battery and test results must be corrected to compensate for temperature differences.

As a battery ages, it continues to perform adequately except that its **capacity** is diminished. Capacity describes the time that a battery can continue to provide its design amperes from a full charge.

A battery has a finite life, therefore good maintenance is designed to maximize the **available** life and reduce the factors that can reduce the life of the battery.

Battery Maintenance

TOOLS

- Insulated Wrench, 9/16"
- Battery Carrier
- Battery Protective Spray
- Hydrometer
- Battery Maintenance Kit (P/N 25587G01)

The batteries can be accessed by raising and removing the seat bottom and battery cover.

At Each Charging Cycle



To reduce the possibility of a fire, never attach a battery charger to a vehicle that is to be unattended beyond the normal charging cycle.

Before charging the batteries, inspect the plug of the battery charger and vehicle receptacle housing for dirt or debris. Charge the batteries after each day of use.

Monthly

- Inspect all wiring for fraying, loose terminations, corrosion, or deterioration of insulation.
- Check that the electrolyte level is correct and add suitable water as required.
- Clean the batteries and wire terminations.
- Torque battery terminal nuts to 95 - 105 in. lbs. (11 - 12 Nm).

MAINTENANCE

- Coat the battery terminals with a commercially available protectant.
- Replace all terminal covers.
- Replace the battery compartment cover and note the service date on the chart.

Temperature Affects Battery Capacity

Battery storage capacity is affected by the temperature; the colder it is, the less energy a battery is able to store; as temperature increases, so does the storage capacity of the battery.

The ideal battery temperature for deep cycle batteries is 77°F (25°C). At 32°F (0°C) the storage capacity of the battery will be reduced by 20%. This means that in cold weather, the vehicle will not travel as far as it would in warm weather.

Electrolyte Level and Water

The correct level of the electrolyte is 1/2" (13 mm) above the plates in each cell.

This level will leave approximately 1/4" - 3/8" (6 - 10 mm) of space between the electrolyte and the vent tube. The electrolyte level is important since any portion of the plates exposed to air will be ruined beyond repair. Also avoid filling with too much water, which will result in electrolyte being forced out of the battery due to gassing, and a decrease in volume of the electrolyte that results from the charging cycle.

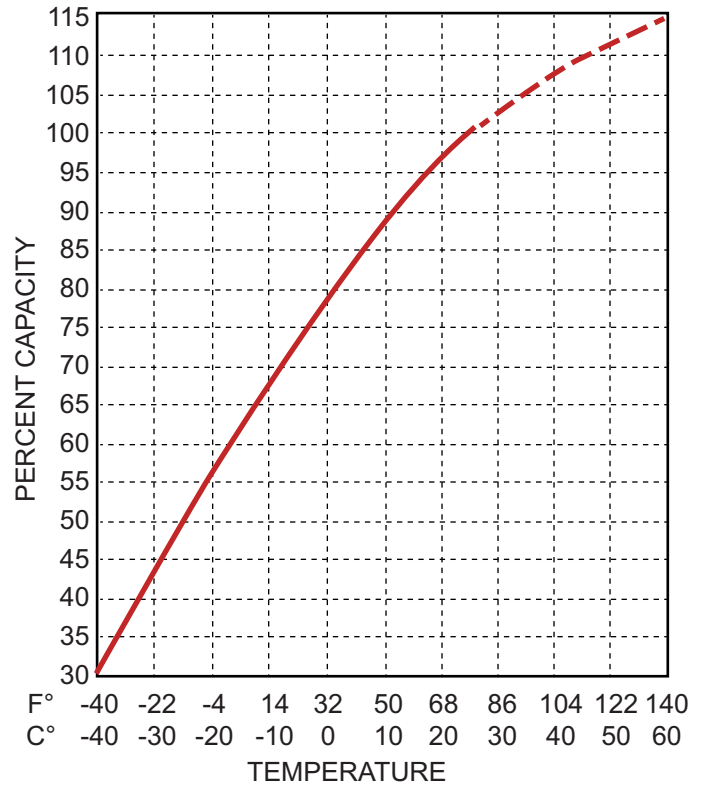

CAUTION

DO NOT overfill batteries. The charging cycle will expel electrolyte and result in component damage.

If the battery electrolyte level is too high, the electrolyte will block the vent tube and the gas will force it out of the vent tube and battery cap. The water will evaporate but the sulfuric acid will remain where it can damage vehicle components and the storage facility floor. Sulfuric acid loss will weaken the concentration of acid within the electrolyte and reduce the life of the battery.

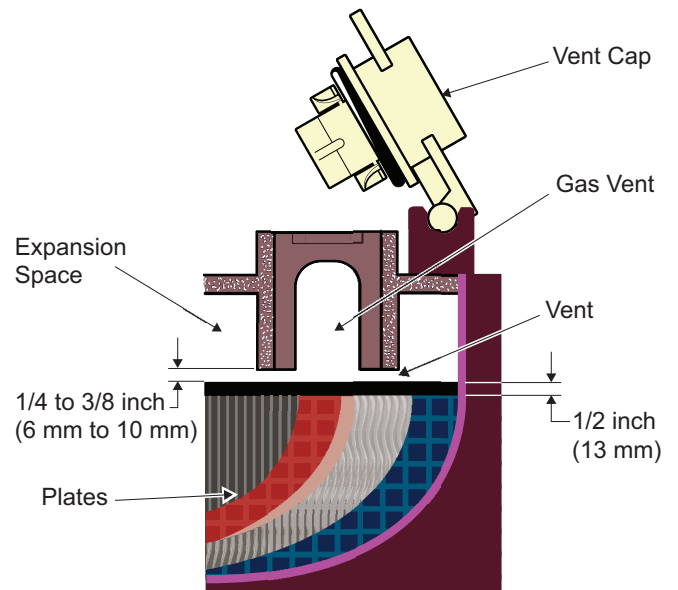

Electrolyte level should be at least 1/2" (13 mm) above the plates and 1/4" to 3/8" (6 to 10 mm) below vent.

Over the life of the battery, a considerable amount of water is consumed. It is important that the water used be pure and free of contaminants that could reduce the life of the battery by reducing the chemical reaction. The water must be distilled or purified by an efficient filtration system. Even if the water is colorless, odorless, tasteless and fit for drinking, the water should be analyzed to see that it does not exceed the impurity levels specified in the table.

An automatic watering gun or a battery watering jug, available from many auto parts stores may be used to fill the batteries. These watering devices are accurate, easy to use and allow for rapid filling. They also maintain the correct electrolyte level within the battery cells.

Impurity	Parts Per Million
Color	Clear
Suspended	Trace
Total Solids	100
Calcium & Magnesium Oxides	40
Iron	5
Ammonia	8
Organic & Volatile Matter	50
Nitrites	5
Nitrates	10
Chloride	5

Water Purity Table

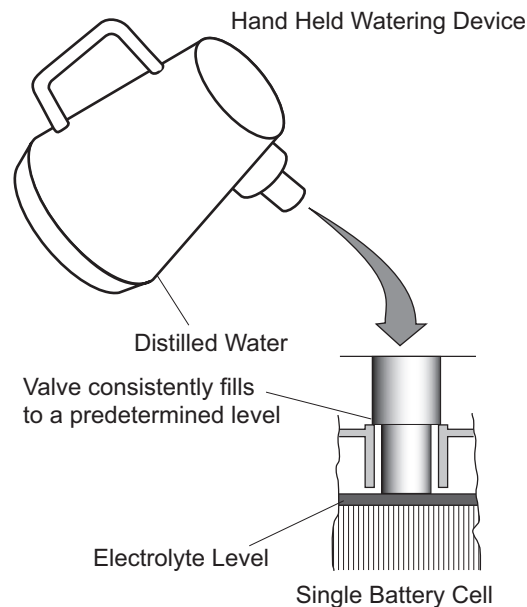
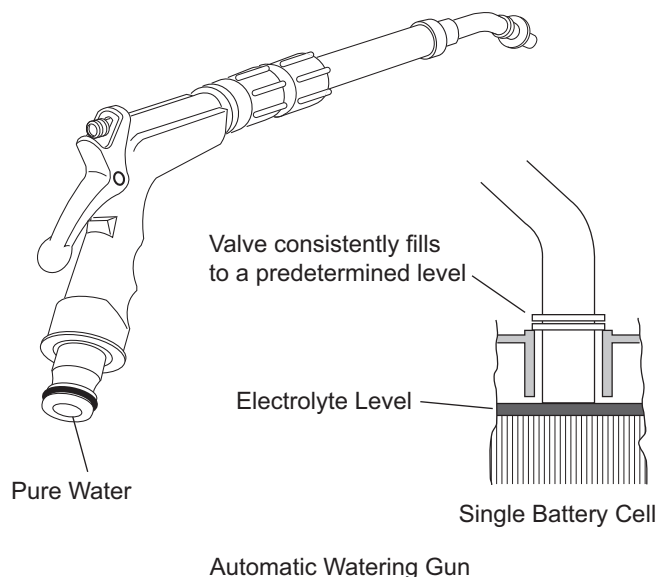

NOTICE: The watering device should only be used if the electrolyte level is less than 1/2" (13 mm) above top of plates.

! WARNING

Electrolyte in a battery is an acid solution which can cause severe burns to the skin and eyes. Treat all electrolyte spills to the body and eyes with extended flushing with clear water. Contact a physician immediately.



Any electrolyte spills should be neutralized with a solution of 2 teaspoons (10 ml) sodium bicarbonate (baking soda) dissolved in 1 quart (1 liter) of water then flushed with clean water.

Always wear a safety shield or approved safety goggles when adding water or charging batteries.

Cleaning Batteries

NOTICE: When cleaning the outside of the batteries and terminals, do not use a water hose without first spraying the batteries with a solution of baking soda (sodium bicarbonate) and water to neutralize any acid deposits. Use of a water hose without first neutralizing the acid will move the acid from the top of the batteries to another area of the vehicle or storage facility, where it will corrode the metal structure or the concrete/asphalt floor. After hosing down the batteries, a residue will be left on the batteries, which is conductive and will contribute to the discharge of the batteries.

! CAUTION

To prevent battery damage, be sure that all battery caps are tightly installed.

The batteries are located under the seat. The batteries can be accessed by raising and removing the seat bottom and battery cover.

Clean batteries according to the Periodic Service Schedule.

1. Use a plastic spray bottle to spray the top and sides of the batteries with a solution of baking soda and water. The solution should consist of:
 - 2 teaspoons (10 ml) sodium bicarbonate (baking soda).
 - 1 quart (1 liter) of water.
2. In addition to the batteries, pay special attention to metallic components adjacent to the batteries. Spray these with the baking soda solution also.
3. Allow the solution to set for at least three minutes; then use a soft bristle brush or cloth to wipe the tops of the batteries to remove any residue that could cause the batteries to self-discharge.

MAINTENANCE

- Rinse the entire area with low pressure clear water.

WARNING

To prevent a battery explosion that could result in severe personal injury or death, use extreme care with aerosol containers of battery terminal protectant. Insulate the metal container to prevent the metal can from contacting the battery terminals.

- After the batteries are clean and dry, coat the terminals with a commercially available protectant. See previous WARNING. Cleaning should take place once a month or more often under extreme conditions.

Battery Removal and Installation

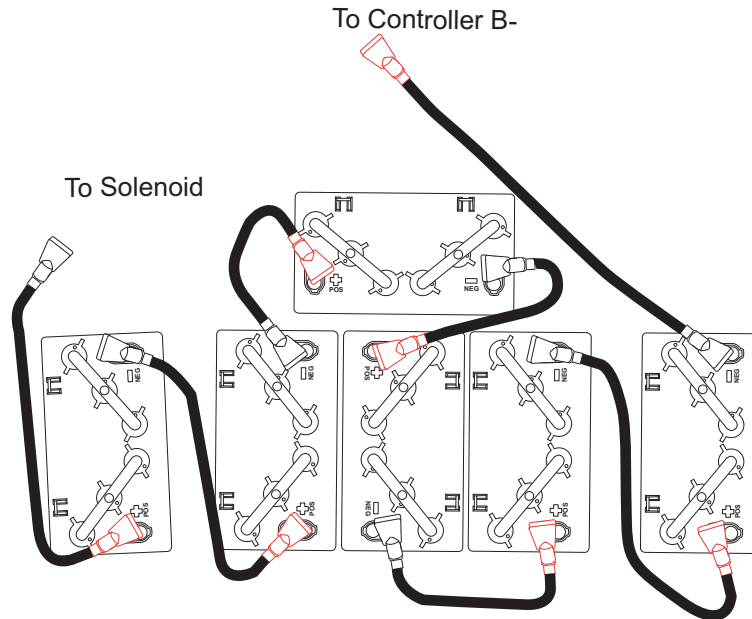

WARNING

Improper handling of high voltage wiring, batteries, or control systems could result in serious or fatal injury by electric shock. Only qualified technicians should repair or access high voltage wiring, battery packs, and associated systems.

To prevent a battery explosion that could result in severe personal injury or death, use extreme caution with aerosol containers of battery terminal protectant. Insulate the metal container to prevent the metal can from contacting the battery terminals, which could result in an explosion.

CAUTION

If the batteries are replaced, make sure they are the exact type and model originally supplied with the vehicle. Failure to follow this caution can result in damage to the electrical system of the vehicle.

Prolonged Storage

During periods of storage, the batteries must be maintained to prevent discharge.

In winter conditions, the batteries must be fully charged to prevent the possibility of freezing. A fully charged battery will not freeze in temperatures above -75° F (-60° C). Although the chemical reaction is slowed in cold temperatures, the battery must be stored fully charged and disconnected from any circuit that could discharge the battery.

The batteries must be cleaned and all deposits neutralized and removed from the battery case to prevent self discharge.

The battery charger may be left connected to the vehicle to maintain a full charge on the batteries, provided the charger is plugged into an active electrical source. If power to the electrical source is disconnected or interrupted, the battery charger will continue to check the charge on the battery pack. This will draw power from the battery pack and eventually drain the batteries if power is not restored in a timely manner.

Battery Charging

The battery charger is designed to fully charge the battery set. If the batteries are severely deep cycled, some automatic battery chargers contain an electronic module that may not activate and the battery charger will not function. Automatic chargers will determine the correct duration of charge to the battery set and will shut off when the battery set is fully charged. Always refer to the manufacturer's instructions of the specific charger being used.

Before charging, the following should be observed:

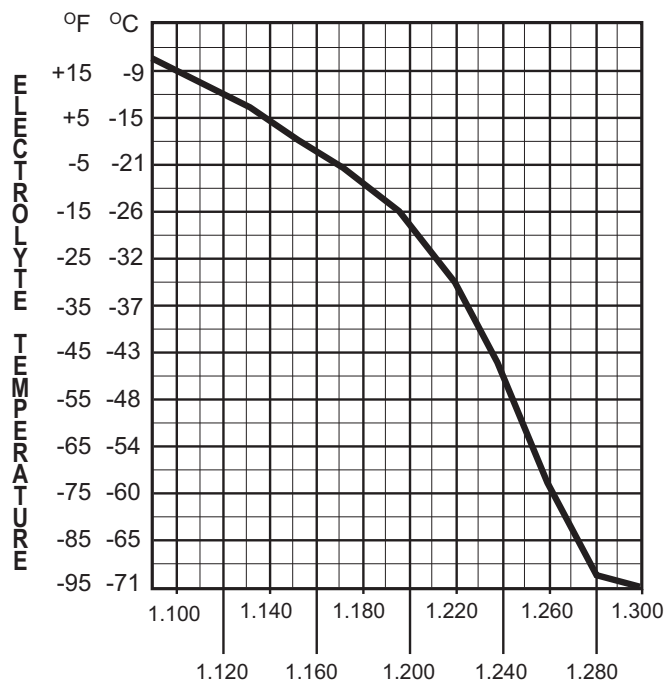

SPECIFIC GRAVITY ELECTROLYTE FREEZING POINT



Do not overfill the batteries. The charging cycle will expel electrolyte and result in component damage.

- The electrolyte level in all cells must be at the recommended level and cover the plates.
- The charging must take place in an area that is well ventilated and capable of removing the hydrogen gas that is generated by the charging process. A **minimum** of five air exchanges per hour is recommended.
- The charging connector components must be in good condition and free from dirt or debris.
- The charger connector must be fully inserted into the vehicle receptacle.
- The charger connector/cord set must be protected from damage and located in an area to prevent injury that may result from personnel running over or tripping over the cord set.
- The charger is automatically turned off during the connect/disconnect cycle and therefore no electrical arc is generated at the DC plug/receptacle contacts.

Battery Troubleshooting

In general, troubleshooting will be done for two distinct reasons:

- A battery that performs poorly and is outside of the manufacturers specification should be identified in order to replace it under the terms of the manufacturer's warranty. Different manufacturers have different requirements. Consult the battery manufacturer or the manufacturer's representative for specific requirements.
- Determine why a particular vehicle does not perform adequately. Performance problems may result in a vehicle that runs slowly or in a vehicle that is unable to operate for the time required.

A new battery must **mature** before it will develop its maximum capacity. Maturing may take up to 100 charge/discharge cycles. After the maturing phase, as the battery ages, its capacity diminishes. The only way to determine the capacity of a battery is to perform a load test using a discharge machine following manufacturer's recommendations

A cost effective way to identify a poorly performing battery is to use a hydrometer to identify a battery in a set with a lower than normal specific gravity. Once the problematic cell or cells are identified, the suspect battery can be removed and replaced. At this point there is nothing that can be done to salvage the battery. The individual battery should be replaced with a good battery of the same brand, type and approximate age.

MAINTENANCE

Hydrometer

A hydrometer is used to test the state of charge of a battery cell. This is performed by measuring the density of the electrolyte, which is accomplished by measuring the specific gravity of the electrolyte. The greater the concentration of sulfuric acid, the more dense the electrolyte becomes. The higher the density, the higher the state of charge.

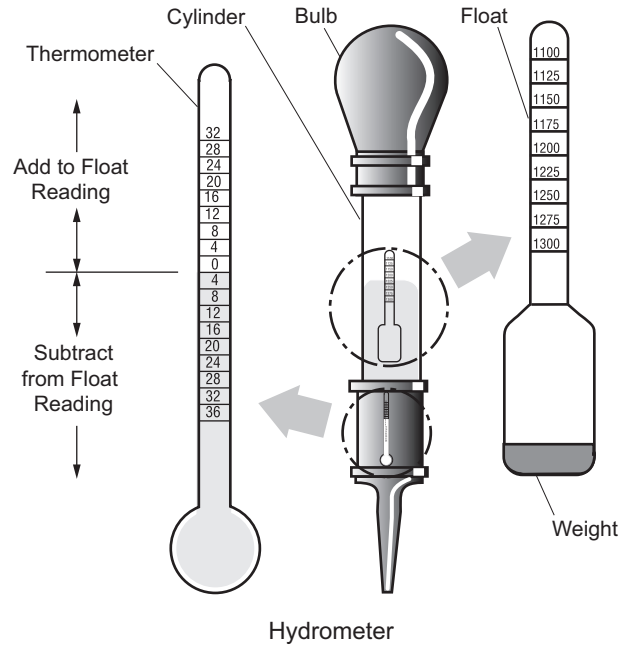

To prevent a battery explosion that could result in severe personal injury or death, never insert a metal thermometer into a battery. Use a hydrometer with a built in thermometer that is designed for testing batteries.

Specific gravity is the measurement of a liquid that is compared to a baseline. The baseline is water and is assigned a base number of 1.000. The concentration of sulfuric acid to water in a new golf car battery is 1.280 meaning that the electrolyte weighs 1.280 times the weight of the same volume of water. A fully charged battery will test at 1.275 - 1.280 while a discharged battery will read in the 1.140 range.

NOTICE: Do not perform a hydrometer test on a battery that has just been watered. The battery must go through at least one charge and discharge cycle in order to permit the water to adequately mix with the electrolyte.

The temperature of the **electrolyte** is important since the hydrometer reading must be corrected to 80° F (27° C). High quality hydrometers are equipped with an internal thermometer that will measure the temperature of the electrolyte and will include a conversion scale to correct the float reading. It is important to recognize that the electrolyte temperature is significantly different from the ambient temperature if the vehicle has been operated.

Using A Hydrometer

WARNING



Electrolyte in a battery is an acid solution which can cause severe burns to the skin and eyes. Treat all electrolyte spills to the body and eyes with extended flushing with clear water. Contact a physician immediately.

Any electrolyte spills should be neutralized with a solution of 2 teaspoons (10 ml) sodium bicarbonate (baking soda) dissolved in 1 quart (1 liter) of water then flushed with clean water.

Always wear a safety shield or approved safety goggles when adding water or charging batteries.

1. Draw electrolyte into the hydrometer several times to permit the thermometer to adjust to the electrolyte temperature and note the reading. Examine the color of the electrolyte. A brown or gray coloration indicates a problem with the battery and is a sign that the battery is nearing the end of its life.
2. Draw the minimum quantity of electrolyte into the hydrometer to permit the float to float freely without contacting the top or bottom of the cylinder.
3. Hold the hydrometer in a vertical position at eye level and note the reading where the electrolyte meets the scale on the float.
4. Add or subtract four points (.004) to the reading for every 10° F (6° C) the electrolyte temperature is above or below 80° F (27° C). Adjust the reading to conform with the electrolyte temperature, e.g., if the reading indicates a specific gravity of 1.250 and the electrolyte temperature is 90° F (32° C), add four points (.004) to the 1.250 which gives a corrected reading of 1.254. Similarly if the temperature was 70° F (21° C), subtract four points (.004) from the 1.250 to give a corrected reading of 1.246.
5. Test each cell and note the readings (corrected to 80° F or 27° C). A variation of fifty points between any two cell readings (example 1.250 - 1.200) indicates a problem with the low reading cell(s).

As a battery ages the specific gravity of the electrolyte will decrease at full charge. This is not a reason to replace the battery providing all cells are within fifty points of each other.

Since the hydrometer test is in response to a vehicle exhibiting a performance problem, the vehicle should be recharged and the test repeated. If the results indicate a weak cell, the battery or batteries should be removed and replaced with a good battery of the same brand, type and approximate age.

ELECTROLYTE TEMPERATURE

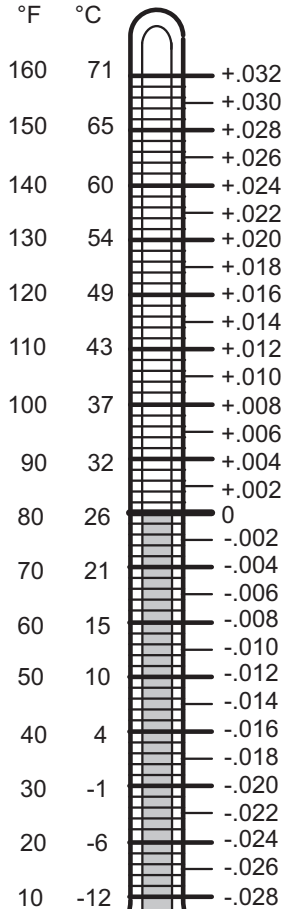

EXAMPLE #1
 ELECTROLYTE TEMPERATURE Above 80 °F (27 °C)
 AMBIENT TEMPERATURE Above 80 °F (27 °C)

ELECTROLYTE TEMPERATURE Above 90 °F (32 °C)
 HYDROMETER READING 1.250
 $1.250 + .004 = 1.254$
 CORRECTED SPECIFIC GRAVITY READING

EXAMPLE #2
 ELECTROLYTE TEMPERATURE Above 80 °F (27 °C)
 AMBIENT TEMPERATURE Above 80 °F (27 °C)

ELECTROLYTE TEMPERATURE Above 70 °F (21 °C)
 HYDROMETER READING 1.250
 $1.250 - .004 = 1.246$
 CORRECTED SPECIFIC GRAVITY READING







Hydrometer Temperature Correction

MAINTENANCE

HARDWARE

Periodically, the vehicle should be inspected for loose fasteners. Use caution when tightening fasteners, refer to the Technician's Repair and Service Manual for specific torque values.

Generally, three classes of standard hardware and two classes of metric hardware are used in the vehicle. Grade 5 hardware can be identified by the three marks on the hex head and grade 8 hardware is identified by six marks on the head. metric hardware is marked on the head with 8.8 or 10.9. Unmarked hardware is Grade 2.

ALL TORQUE FIGURES ARE IN FT. LBS. (Nm)											
Unless otherwise noted in text, tighten all hardware in accordance with this chart.											
This chart specifies 'lubricated' torque figures. Fasteners that are plated or lubricated when installed are considered 'wet' and require approximately 80% of the torque required for 'dry' fasteners.											
BOLT SIZE		1/4"	5/16"	3/8"	7/16"	1/2"	9/16"	5/8"	3/4"	7/8"	1"
Grade 2 		4 (5)	8 (11)	15 (20)	24 (33)	35 (47)	55 (75)	75 (102)	130 (176)	125 (169)	190 (258)
Grade 5 		6 (8)	13 (18)	23 (31)	35 (47)	55 (75)	80 (108)	110 (149)	200 (271)	320 (434)	480 (651)
Grade 8 		6 (8)	18 (24)	35 (47)	55 (75)	80 (108)	110 (149)	170 (230)	280 (380)	460 (624)	680 (922)
BOLT SIZE		M4	M5	M6	M8	M10	M12	M14			
Class 5.8 (Grade 2) 		1 (2)	2 (3)	4 (6)	10 (14)	20 (27)	35 (47)	55 (76.4)			
Class 8.8 (Grade 5) 		2 (3)	4 (6)	7 (10)	18 (24)	35 (47)	61 (83)	97 (131)			
Class 10.9 (Grade 8) 		3 (4)	6 (8)	10 (14)	25 (34)	49 (66)	86 (117)	136 (184)			

Torque Specifications and Bolt Grades

CAPACITIES AND REPLACEMENT PARTS

CAPACITIES	
Front Axle Oil	13.8 oz. 90 wt. Gear Oil
Rear Axle Oil	13.8 oz. 90 wt. Gear Oil
Brake Fluid	DOT 4

REPLACEMENT PARTS	
LED Headlight Bulb	P/N 651411G03
Headlight Bulb	P/N 651411G01
Mini Fuse 32V 10A	636455G12
Mini Fuse 32V 15A	636455G13
Mini Fuse 32V 20A	636455G14
Mini Fuse 125V 10A	636455G05
Mini Diode 400V 1A	647667
72V Relay	650845

PERIODIC SERVICE SCHEDULE

Item	Interval (perform at interval that comes first)		Remarks	Page
	Hours	Calendar		
Overall vehicle condition	Pre-ride		Inspect.	
Batteries	Pre-ride		Check state of charge, battery condition, loose terminals, corrosion, hold down and hardware.	
Steering	Pre-ride		Check for smooth and free operation.	
Front suspension	Pre-ride		Inspect. Check for leaks and loose or missing hardware.	
Rear suspension	Pre-ride		Inspect. Check for leaks and loose or missing hardware.	
Tires	Pre-ride		Check condition and pressure.	10
Wheel lug nuts	Pre-ride		Check for loose or missing.	27
Accelerator	Pre-ride		Check for smooth operation.	11
Brake system	Pre-ride		Check for smooth operation and acceptable stopping distance.	29
Frame hardware	Pre-ride		Check for loose or missing.	
Headlights and taillights	Pre-ride		Check operation. Replace bulbs as needed.	27
Reverse warning alarm	Pre-ride		Check operation.	
Switches	Pre-ride		Check operation.	
Fluid leakages	Pre-ride		Inspect entire vehicle for leaks	
S Brake shoes	10	Monthly	Inspect. Replace as needed.	
Batteries	20	Monthly	Clean.	
Batteries	20	Monthly	Check electrolyte level; fill with water (distilled only) if required.	
Charger receptacle	20	Monthly	Clean connections.	
Parking brake	20	Monthly	Conduct brake performance test; adjust as necessary. Check for correct hold on an incline.	
Accelerator	20	Monthly	Check for smooth operation.	
Wiring	20	Monthly	Inspect for loose connections, broken or missing insulation.	
Steering	20	Monthly	Check for excess play, loose or missing hardware.	
S Tie rods	20	Monthly	Check for excess play, bent rods, loose or missing hardware.	
Front suspension	20	Monthly	Inspect strut for leaks. Check hubs and kingpins, for excessive play, worn bushings, loose or missing hardware.	
Rear axle	20	Monthly	Check for leakage; add oil as required.	
Brakes	20	Monthly	Check for smooth operation and acceptable stopping distance.	29
Front wheel alignment	60	3 Months	Check for unusual tire wear.	
Rear Suspension	60	3 Months	Check for shock oil leakage, worn bushings, loose or missing hardware.	
S General lubrication	50	3 Months	Lubricate all fittings, pivots, cables, etc. where required.	23
Check brake fluid (If equipped with hydraulic brakes)	100	1 year	Check hydraulic brake fluid for contamination and level.	
Rear axle	500	5 years	Replace fluid.	
Motor coupling	20,000 Amp Hours	5 years	Add anti-seize compound (approx. 1 tbsp.)	

NOTICE: Some maintenance items must be serviced more frequently on vehicle used under severe driving conditions.

SPECIFICATIONS

SPECIFICATIONS CHART

Item	Specification
Total Capacity	940 lb (426 kg)
Towing Capacity	1,000 lb (453.6 kg)
Speed Maximum	24.5 mph (kph)
Range Maximum	16 mph (kph)
Overall Length	118 in (284 cm)
Overall Width	53 in (134.6 cm)
Overall Height	76.8 in (195.1 cm)
Overall Weight	1,710 lb (775.6 kg)
Wheelbase	70 in (178 cm)
Ground Clearance - Frame Center	16 in (41 cm)
Ground Clearance - Axle	9.5 in (24 cm)
Hitch	2 in (5 cm)
Front Tires	25 X 8 - 12
Rear Tires	25 X 10 - 12
Wheels	Steel
Steering	Rack and Pinion
Front Suspension	Independent MacPherson Struts
Rear Suspension	Independent MacPherson Struts
Brake System	4 - Wheel Hydraulic Disc
Parking Brake	IntelliBrake™ System
Battery	72V Battery System
	6 - 12V Heavy-Duty Deep Cycle Batteries
Motor Type	72V (Front and Rear)
Horsepower	38 HP
Drivetrain	72V AC Electric
Gear Selection	Dash Mounted Direction Selector Switch (Forward - Neutral - Reverse)
Differentials	Open
Regenerative Braking	Yes
Charger	Off - Board 72V Charger
Charge Time	Approximately 8 - 12 hours
Frame	Structurally Welded High - Strength Steel
Finish	DuraShield Powder Coat; Automotive Quality Impact - Resistant TPO Plastic
Standard Color	Black
Optional Color	TrueTimber™ Kanati Camo
Instrumentation	In - Dash Battery Status Indicator
	12V DC Outlet
Seating	Forward Facing Bench Seat
	Convertible Rear - Facing Bench Seat
Storage Components	Fold - Down Cargo Deck
	Glove Box
Safety Components	3 - Point Seat Belts (2 Front, 2 Rear)
	Safety Nets
	1.75 in. Formed Tube OPS
	1.5 in. Diameter Tubing Brush Guard
	Headlights
	Taillights
	Impact - Resistant Fender Flares

SPECIFICATIONS

MAINTENANCE LOG

MAINTENANCE LOG

Record periodic maintenance in the following maintenance log.

DATE	MILES (KM) AND HOURS	TECHNICIAN	SERVICE PERFORMED COMMENTS

MAINTENANCE

DATE	MILES (KM) AND HOURS	TECHNICIAN	SERVICE PERFORMED COMMENTS

Normal use, age and wear on vehicle components can affect the safe operation and reliability of the vehicle. The recommended Inspection and maintenance procedures are crucial for safety, performance, reliability and maximum longevity of your vehicle.

A damaged vehicle, or a vehicle that is not functioning properly is dangerous and must not be operated until repairs are made.

NOTICE: Read the following operational warnings before driving the vehicle:

WARNING

Before you leave the vehicle, turn the key to the OFF position and remove the key from the vehicle to prevent unauthorized use.

Drive the vehicle at appropriate speeds for the terrain and conditions. Be aware of environmental conditions that change the terrain and your ability to control the vehicle.

Do not drive on excessively steep hills. Evaluate the terrain before descending a hill. Drive slowly and deliberately. Use the brake to limit speed and maintain control. Sudden braking or turning can cause loss of vehicle control. Drive straight down the hill; do not drive across the hill.

Operate in approved areas.

Keep feet, legs, hands and arms inside vehicle at all times.

Avoid driving on terrain that is too rough for your vehicle's capabilities and your driving skills.

Before you drive in the reverse direction, make sure the area behind the vehicle is clear. Accelerate slowly and avoid making sharp turns.

Make sure the direction selector is in the correct position before you press the accelerator pedal.

Decrease speed before and during turns.

Bring the vehicle to a complete stop before you move the direction selector.

See GENERAL SPECIFICATIONS for the vehicle load and seat capacity.

NOTICE: Read the following maintenance information and warnings before servicing or repairing the vehicle:

Follow the procedures and comply with the safety information in this manual when performing vehicle service or maintenance.

Use the tools shown in the tool list and wear the specified safety equipment when performing vehicle service or maintenance.

WARNING

Remove all jewelry before you service the vehicle.

Do not allow loose clothing or hair to contact the moving parts.

Do not touch hot objects.

The drive wheels must be lifted and supported on jack stands before you perform any service to the powertrain while the motor is in operation.



When you service the vehicle, always wear eye protection. Be careful when working around batteries, using solvents or compressed air.

Use insulated wrenches to decrease the risk of a short-circuit if a wrench contacts the battery terminals. A short-circuit in a battery can cause an explosion.

To prevent the risk of battery explosion, keep all flammable materials, open flames or sparks away from the batteries.

Hydrogen gas is produced as batteries are charged. Charge batteries only in well-ventilated areas.

Maintain constant awareness that some components are heavy, spring loaded, corrosive, explosive, can cause high amperage or get extremely hot. Battery acid and hydrogen gas can cause bodily injury. Keep your hands, face, feet and body away from any area that can expose them to injury if an unexpected situation occurs.

TRACKER

OFF ROAD

California Proposition 65

 **WARNING**

Operating, servicing and maintaining a passenger vehicle or off-road vehicle can expose you to chemicals including phthalates and lead, which are known to the State of California to cause cancer and birth defects or other reproductive harm. To minimize exposure, wear gloves and wash your hands frequently when servicing your vehicle.

For more information go to www.P65Warnings.ca.gov/passenger-vehicle.

MANUFACTURER INFORMATION

Textron Specialized Vehicles Inc.
1451 Marvin Griffin Road
Augusta, GA, USA 30909-3852

Dealer: 800-296-4804
Consumer: 877-394-6772

www.trackeroffroad.com

Service Parts Manuals and Repair Manuals are available from the manufacturer.

Copyrighted Material

This manual may not be reproduced in whole or in part without the express permission of the manufacturer.